

Frank Türen AG
T 041 624 90 90
www.frank-tueren.ch

Rahmentür EI30, 1-flügelig, Rahmentürblatt mit Glas- oder Füllungseinsatz

Massangaben in mm

VKF Nr. 23698

Massstab 1:25 Seite 2

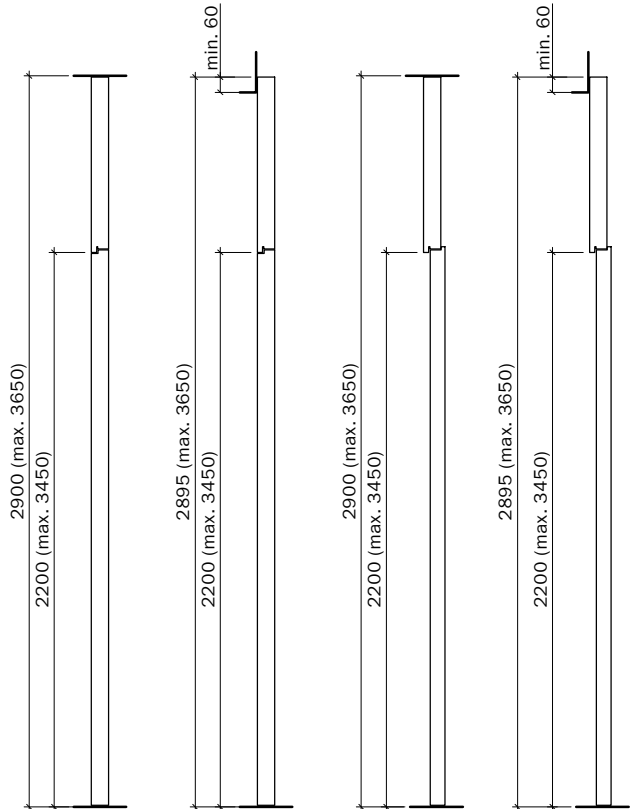
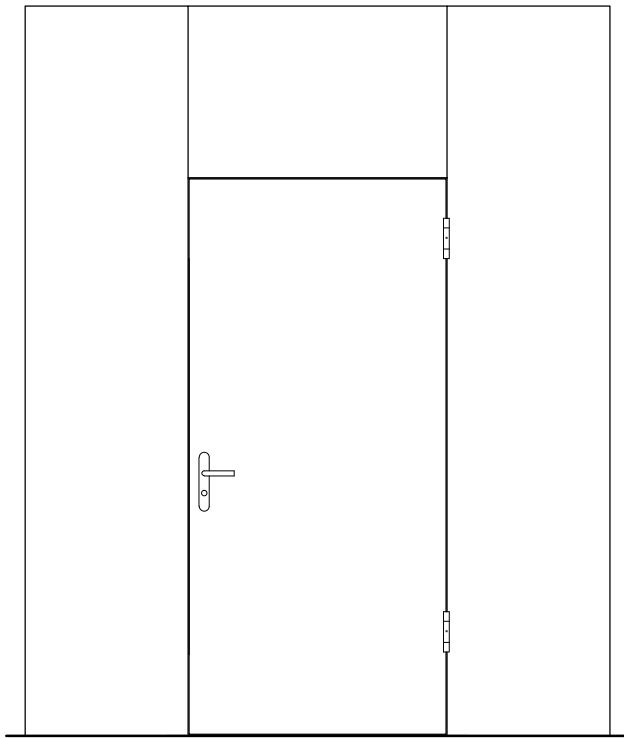

2320 (Elementbreite endlos)

1000 (max. 1840)

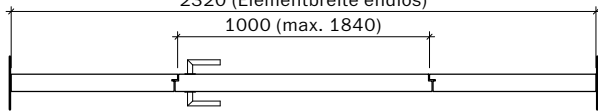

2320 (Elementbreite endlos)

1000 (max. 1840)

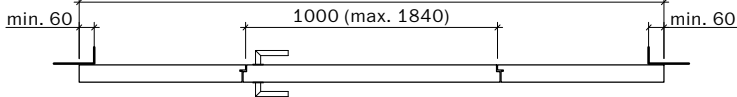

2320 (Elementbreite endlos)

1000 (max. 1840)

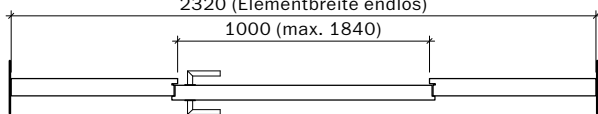

2320 (Elementbreite endlos)

1000 (max. 1840)

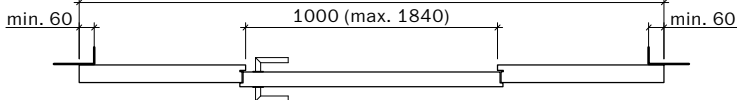

Frank Türen AG
T 041 624 90 90
www.frank-tueren.ch

Rahmentür EI30, 1-flügelig, Volltürblatt mit Seiten- und Oberteil mit/ohne Glas- oder Füllungsausschnitt

Massangaben in mm

VKF Nr. 23677, 23679

Massstab 1:30 Seite 3

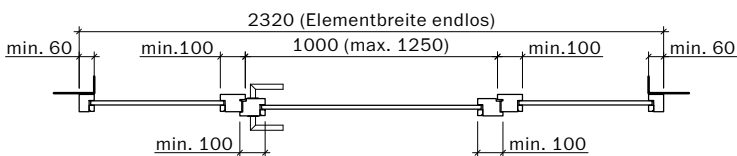
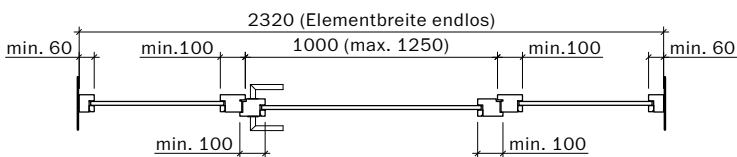
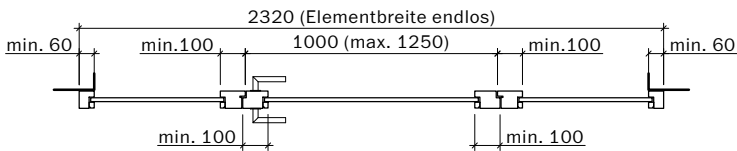
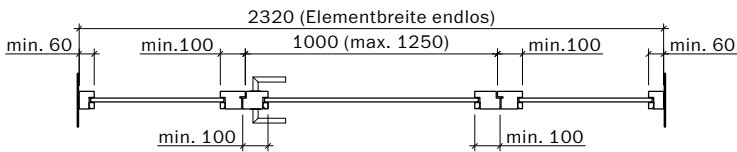
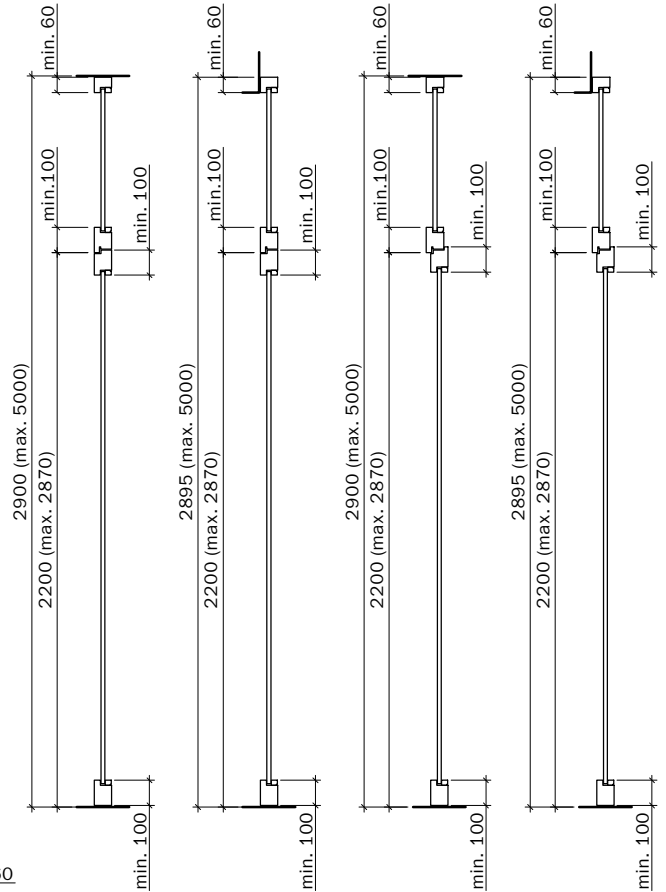
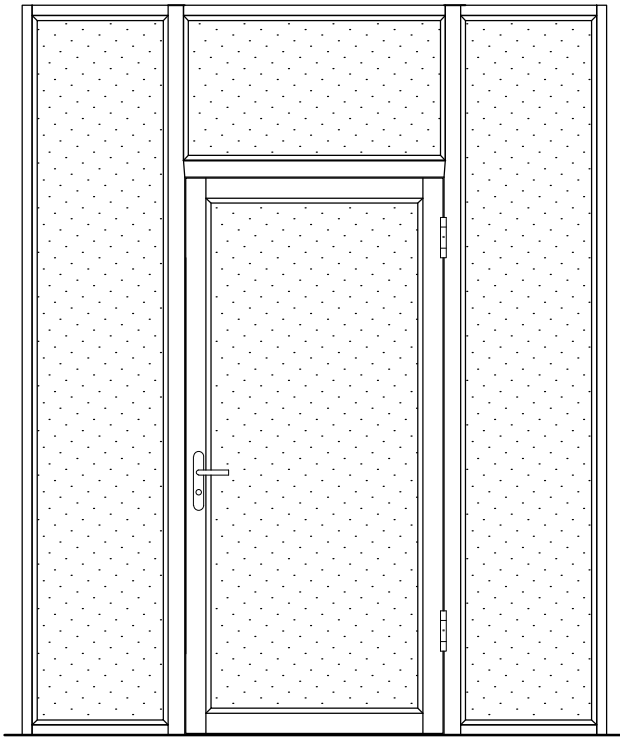

Frank Türen AG

T 041 624 90 90
www.frank-tueren.ch

Rahmentür EI30, 1-flügelig, Rahmentürblatt mit Seiten- und Oberteil mit Glas- oder Füllungseinsatz

Massangaben in mm

VKF Nr. 23701, 23720

Massstab 1:30 Seite 4

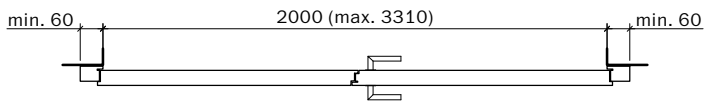
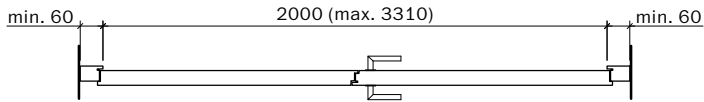
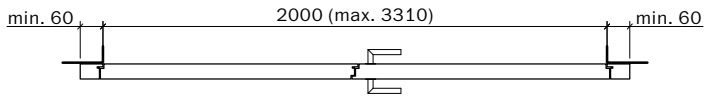
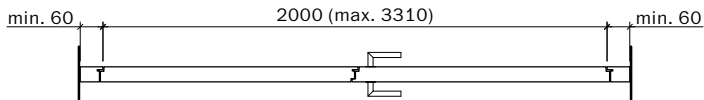
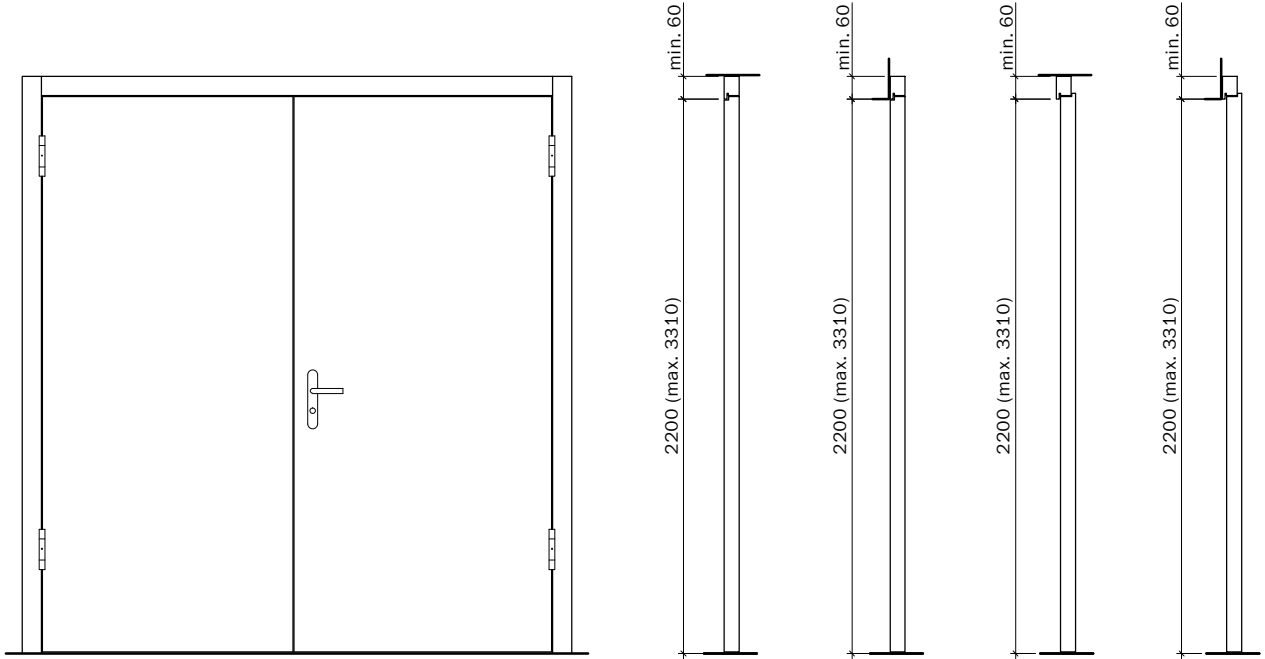

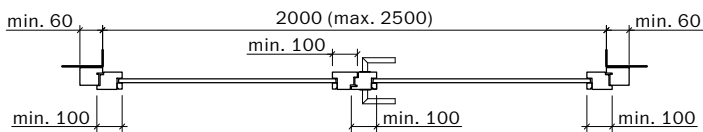
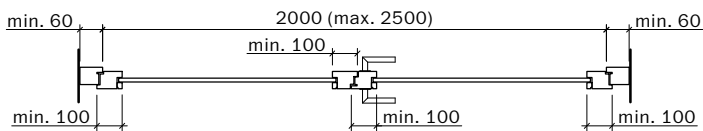
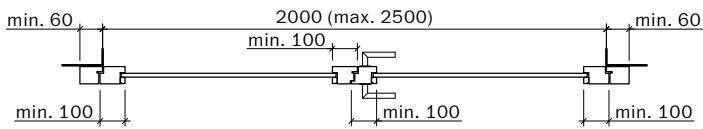
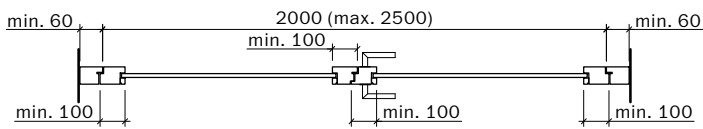
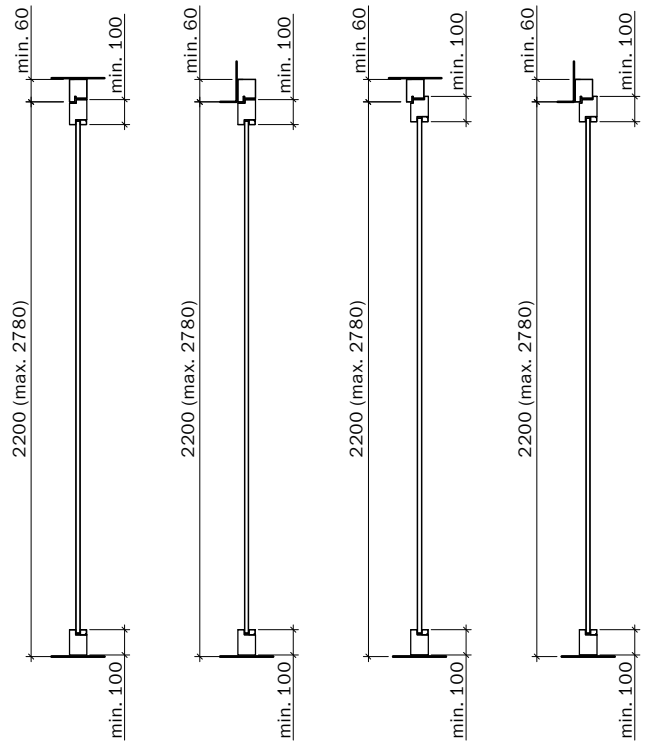
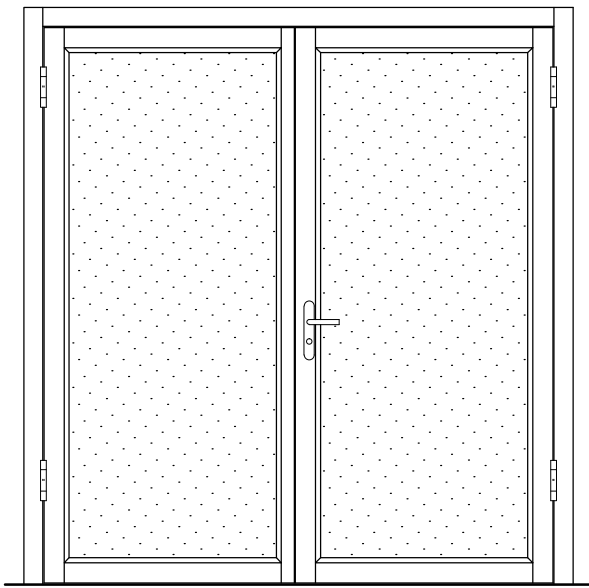

Frank Türen AG
T 041 624 90 90
www.frank-tueren.ch

Rahmentür EI30, 2-flügelig, Rahmentürblatt mit Glas- oder Füllungseinsatz

Massangaben in mm

VKF Nr. 23700, 19714

Massstab 1:30 Seite 6

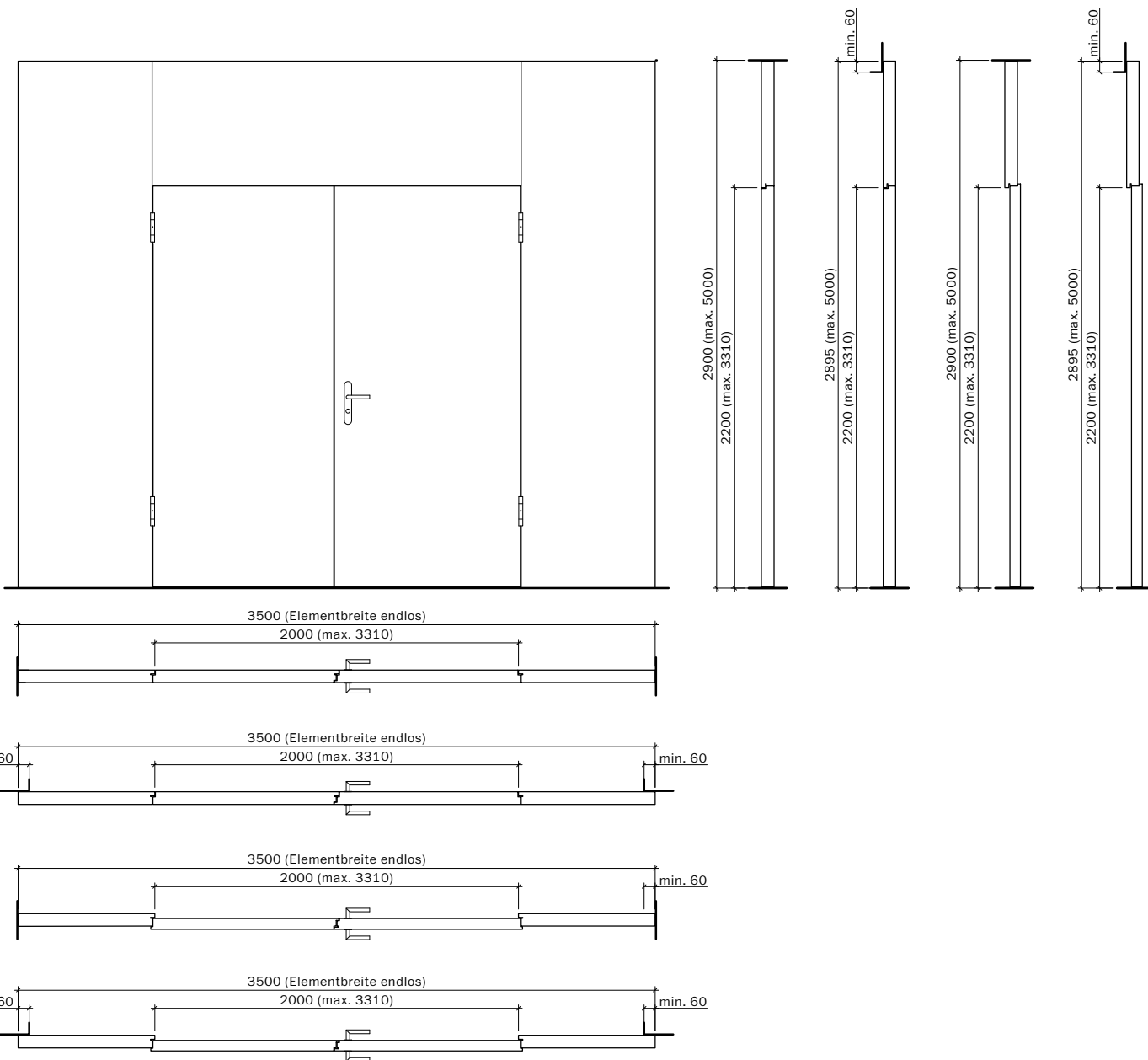

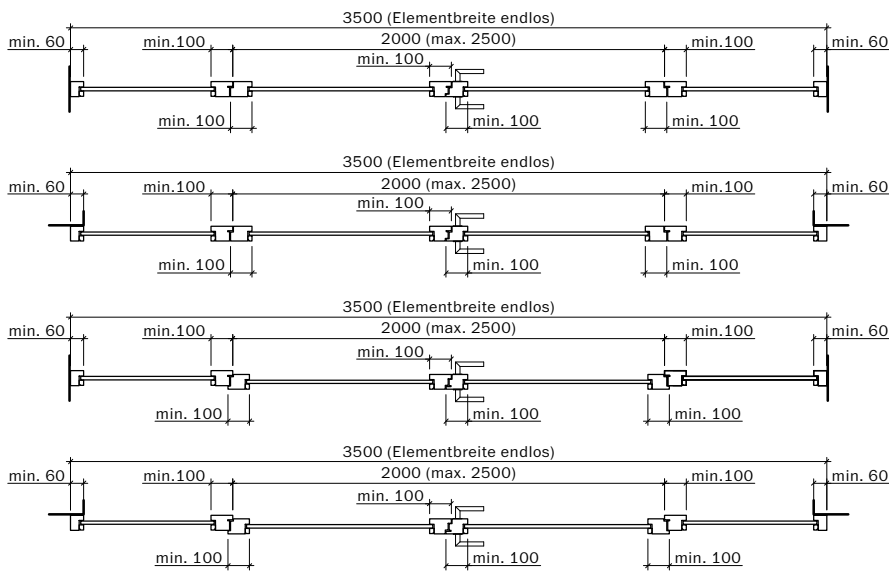
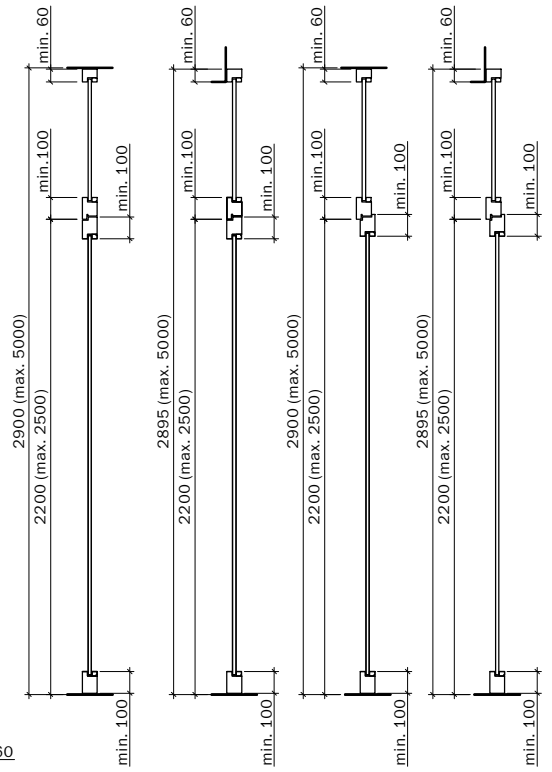
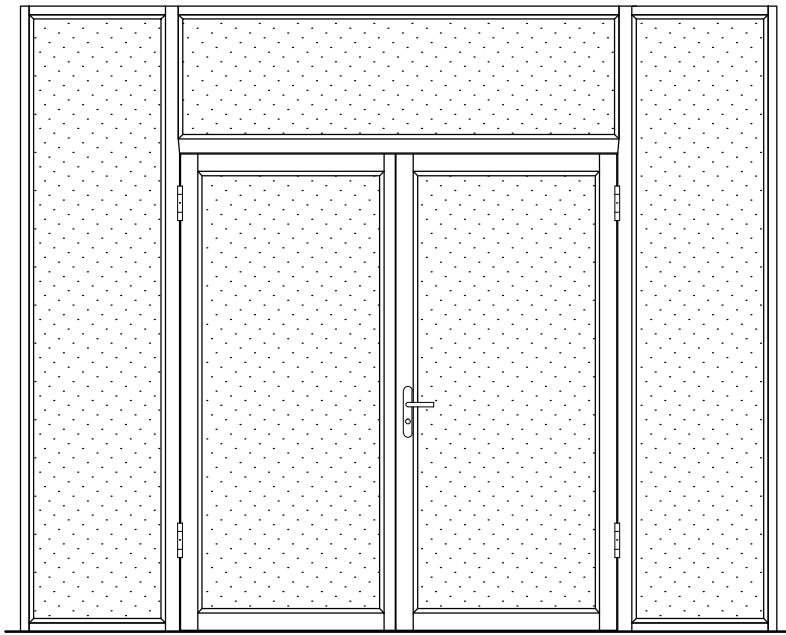

Frank Türen AG
 T 041 624 90 90
 www.frank-tueren.ch

Rahmentür EI30, 2-flügelig, Rahmentürblatt mit Seiten- und Oberteil mit Glas- oder Füllungseinsatz

Massangaben in mm

VKF Nr. 23702 , 23721

Masstab 1:35 Seite 8

