

Aussen

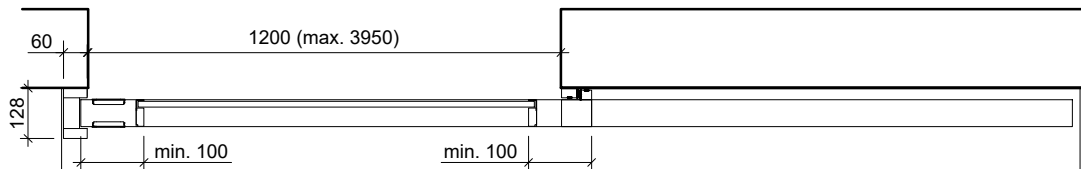

Innen

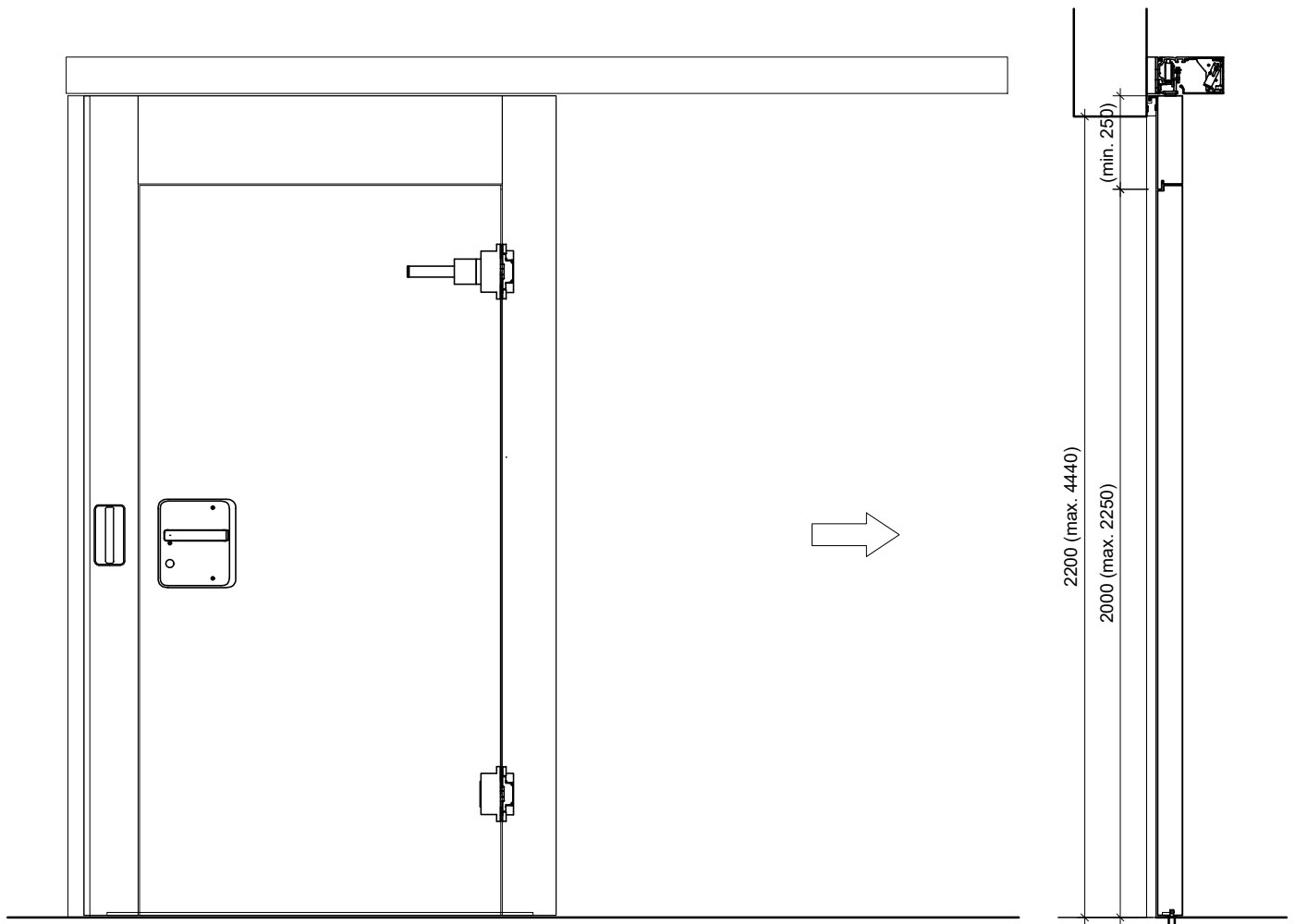



Aussen

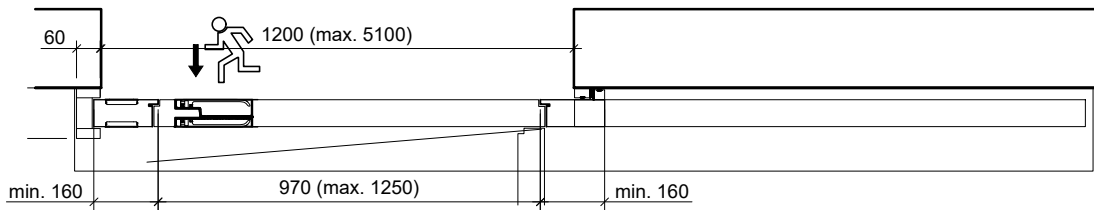

Innen



Frank Türen AG
T 041 624 90 90
www.frank-tueren.ch

Automatisch, 1-flg, mit Anschlag vorne, mit Fluchtwegtüre

Massangaben in mm

VKF Nr. 26364, 26365

Massstab 1:20 Seite 3

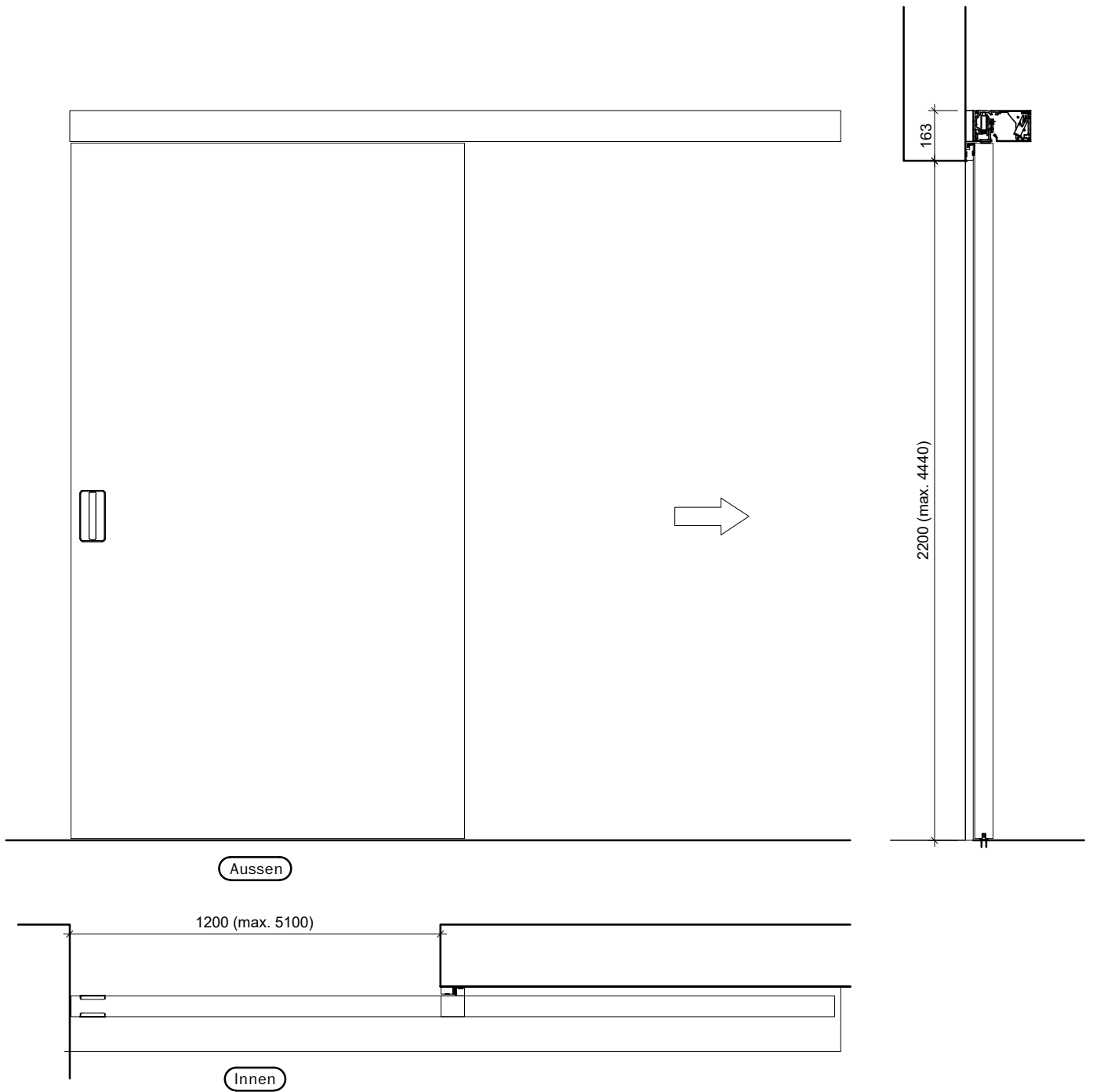

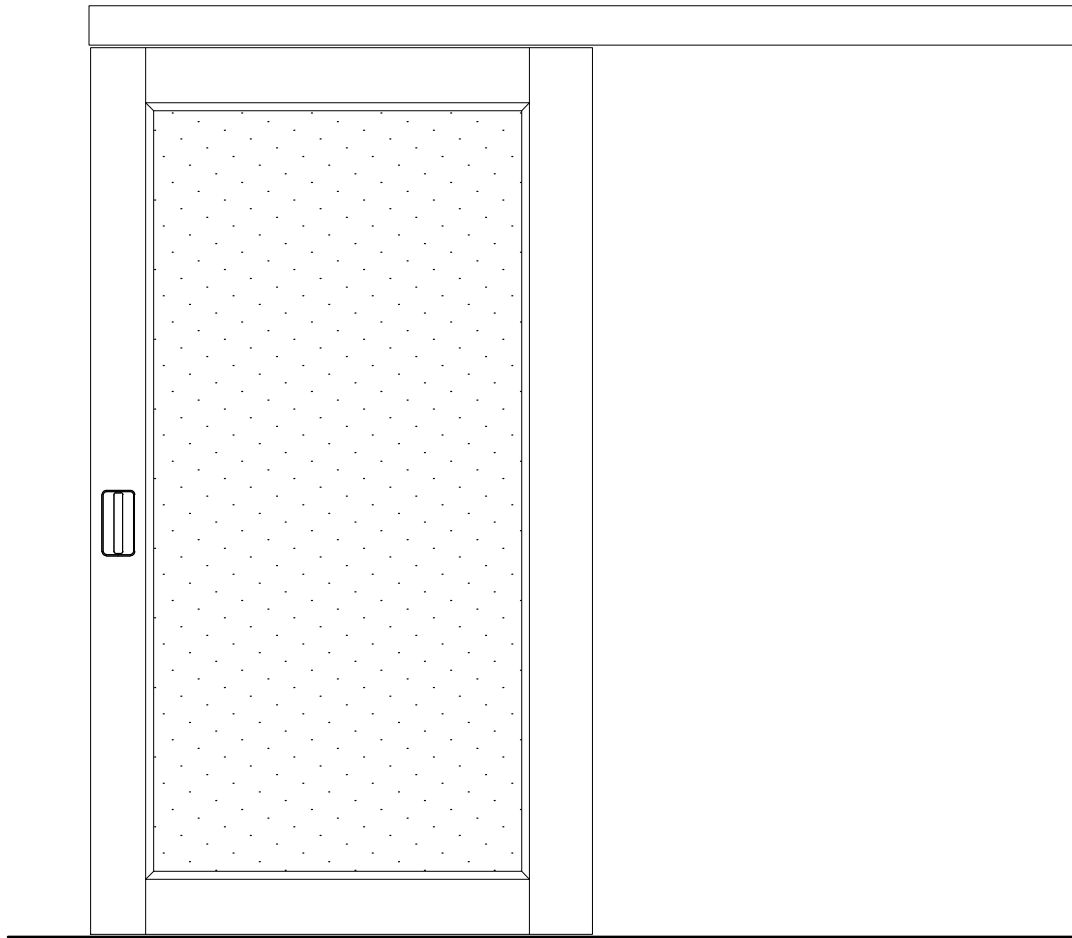

Aussen

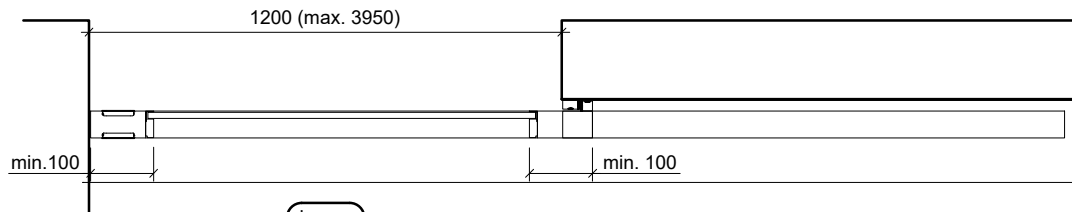
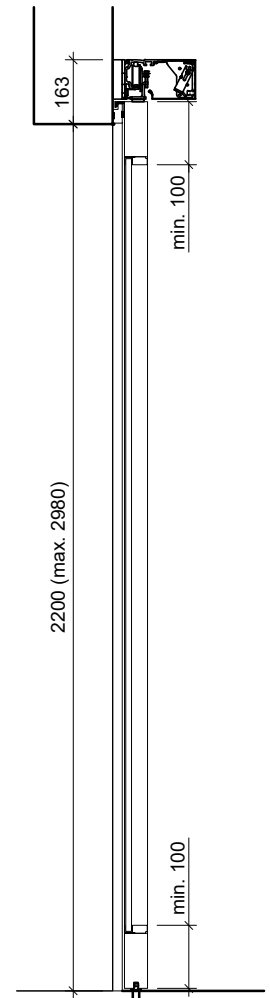

Innen



Frank Türen AG
T 041 624 90 90
www.frank-tueren.ch

Automatisch, 1-flg, Stumpfanschlag, mit Friestüre

Massangaben in mm

VKF Nr. 25492

Masstab 1:20 Seite 5

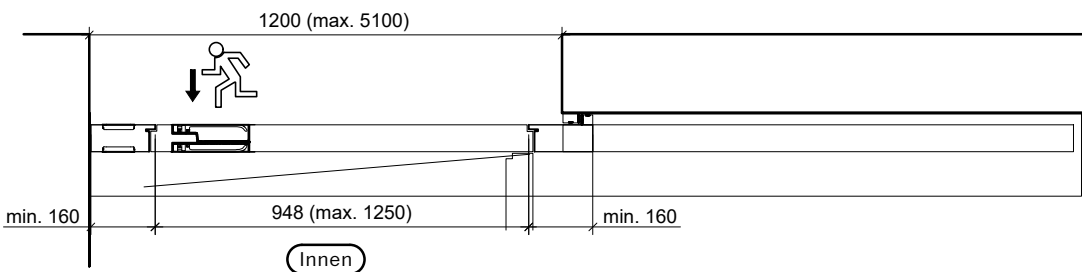
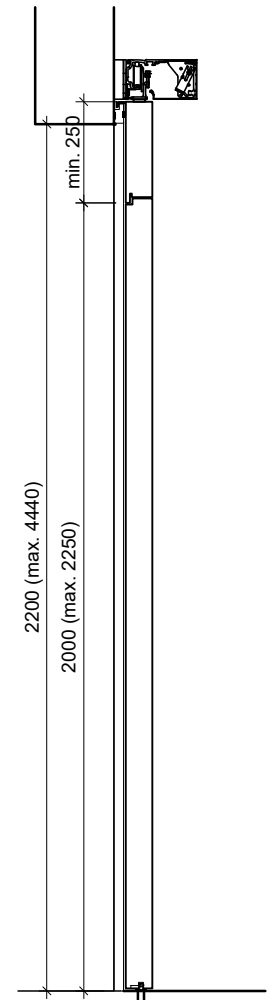
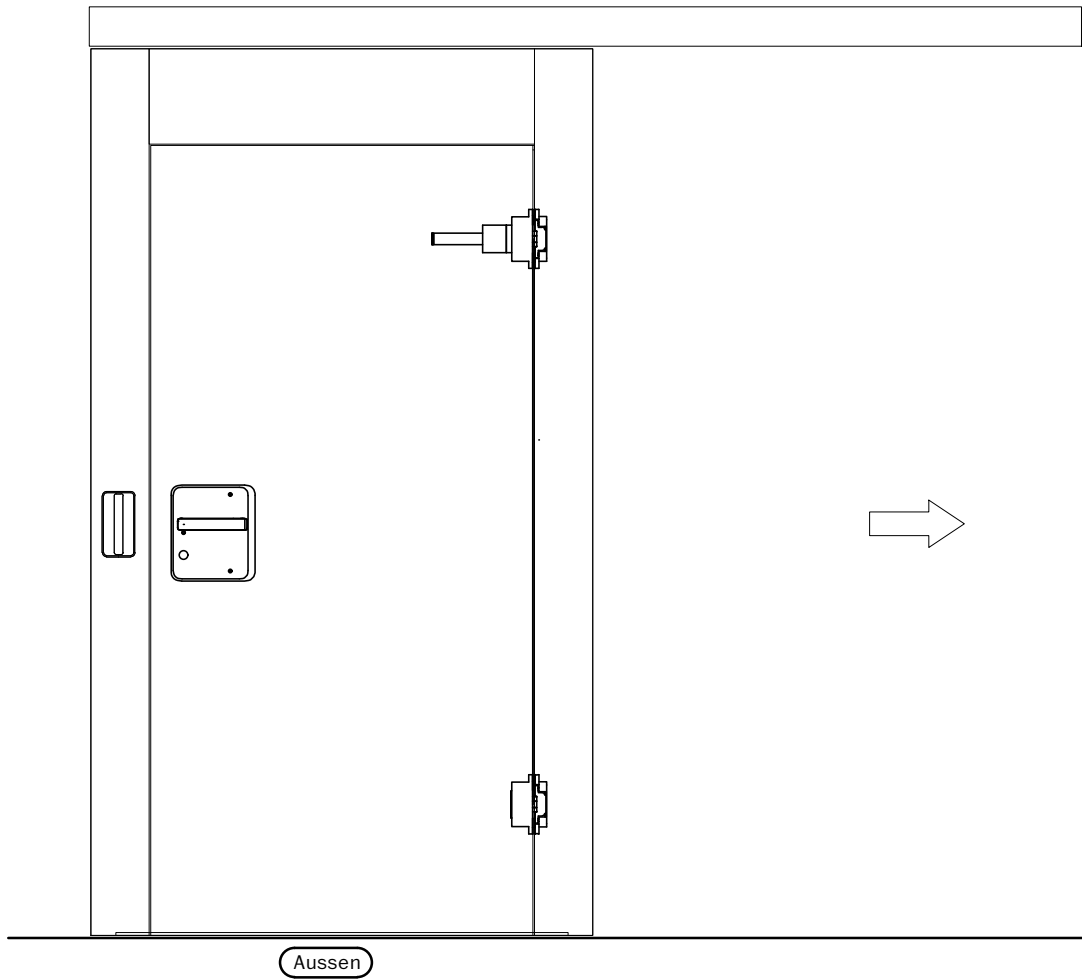

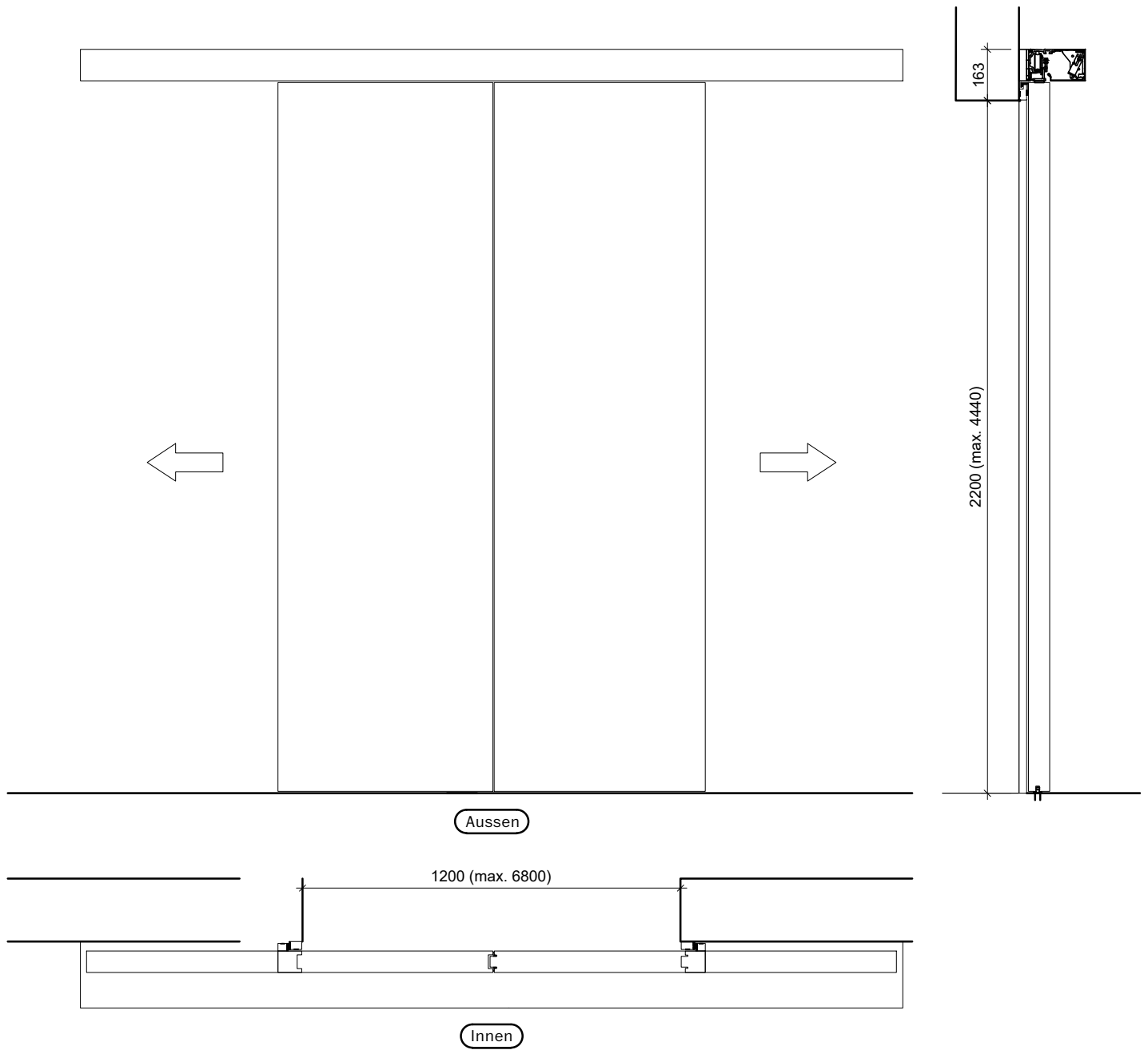

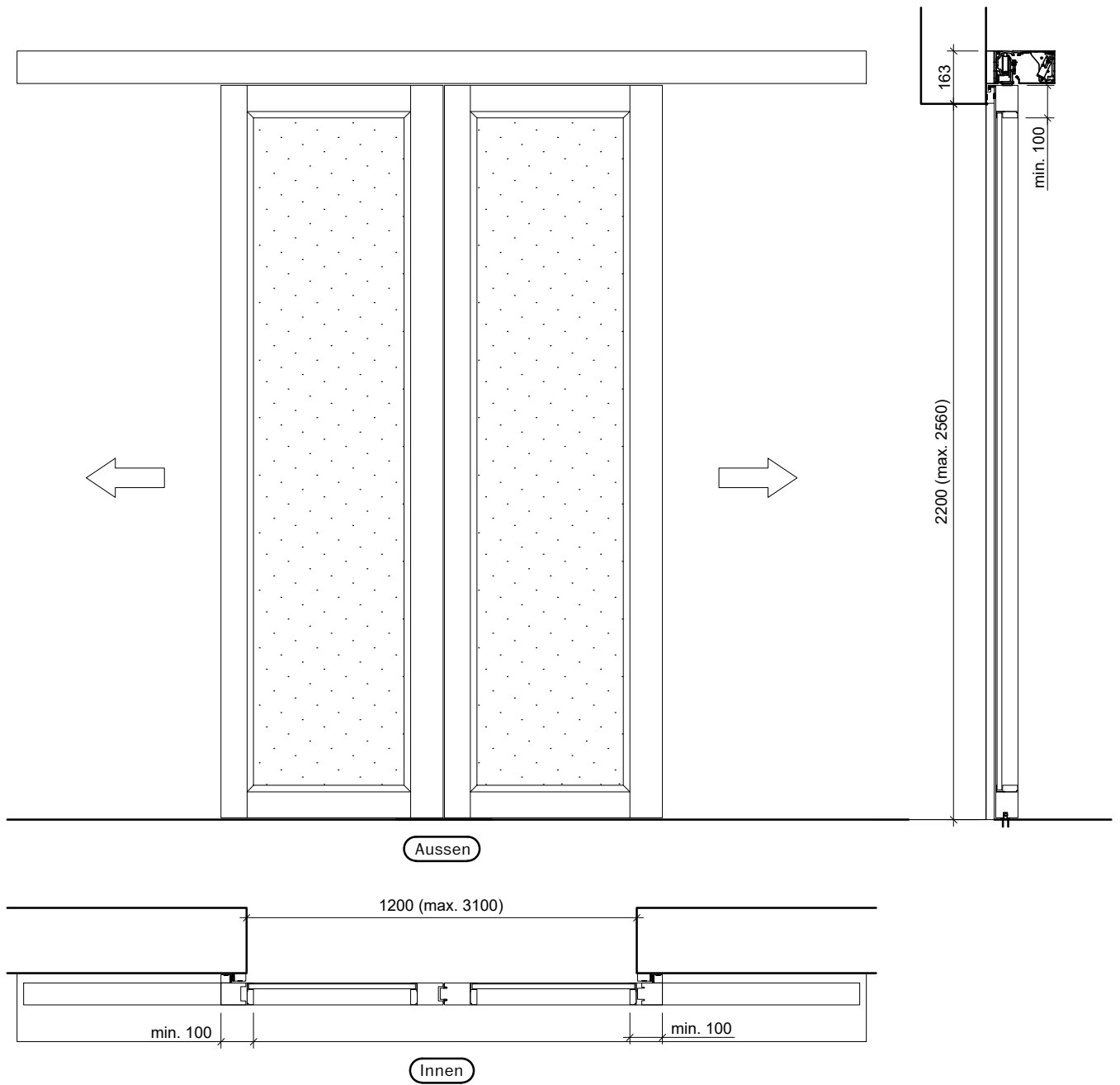

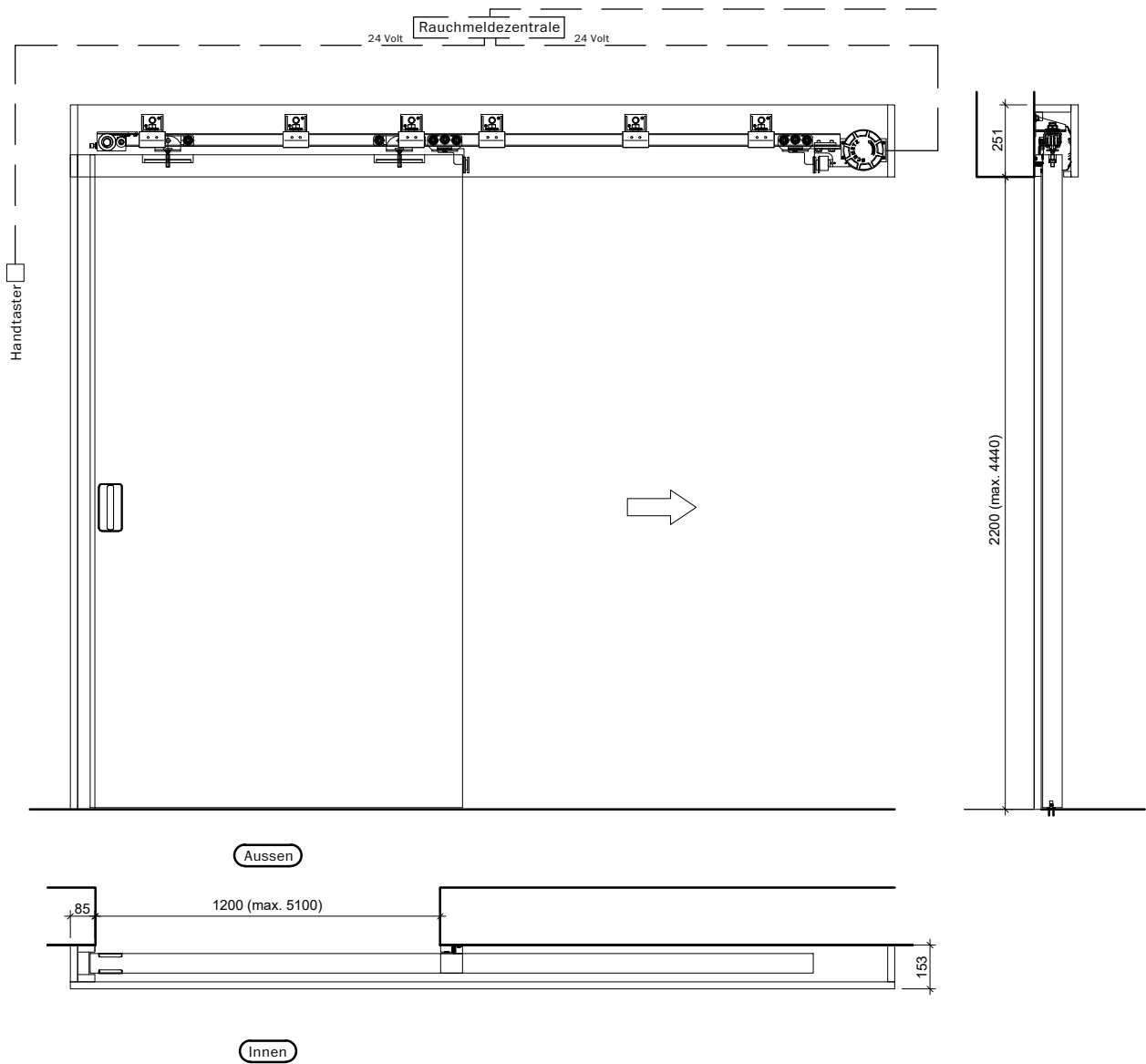

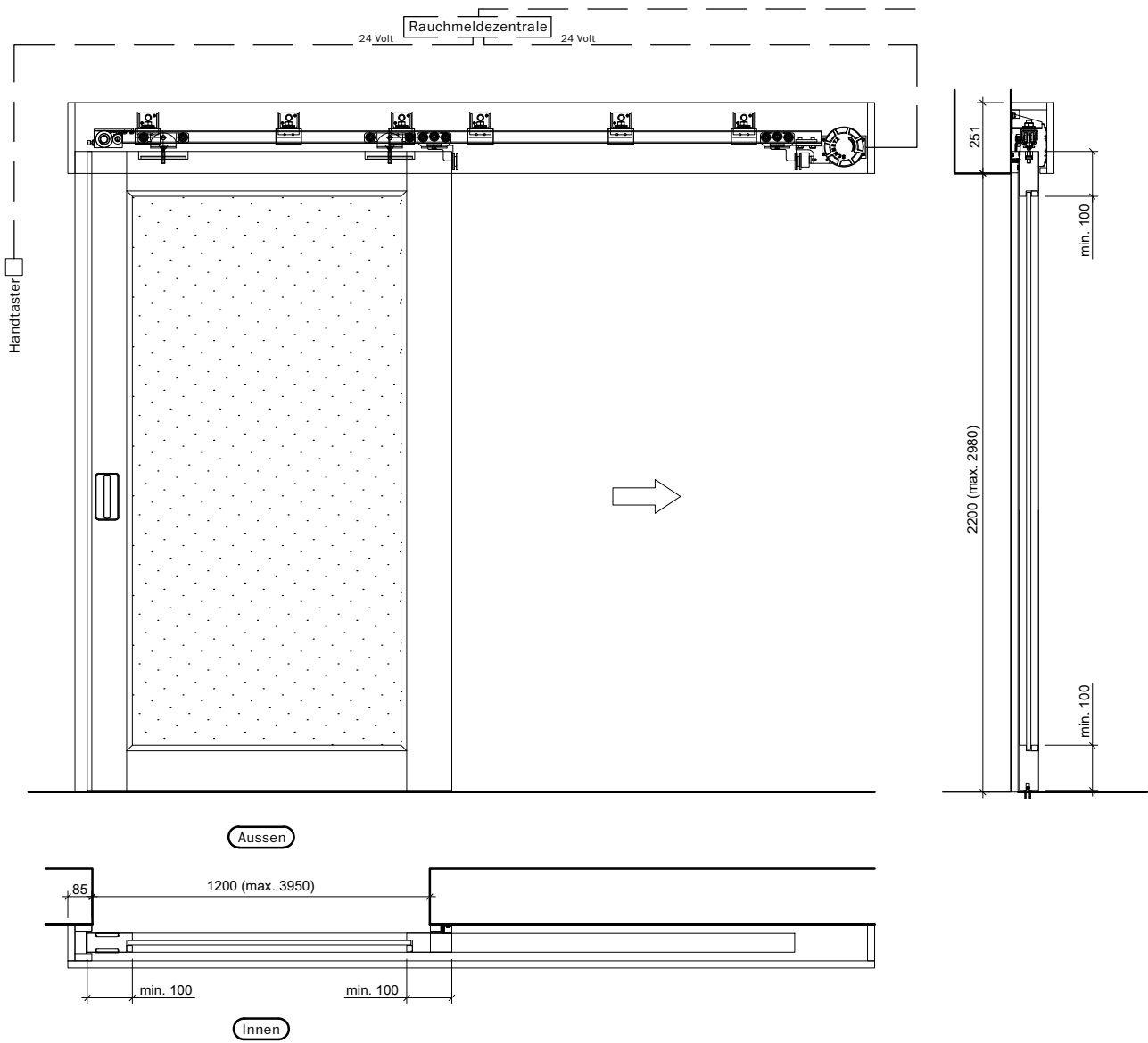

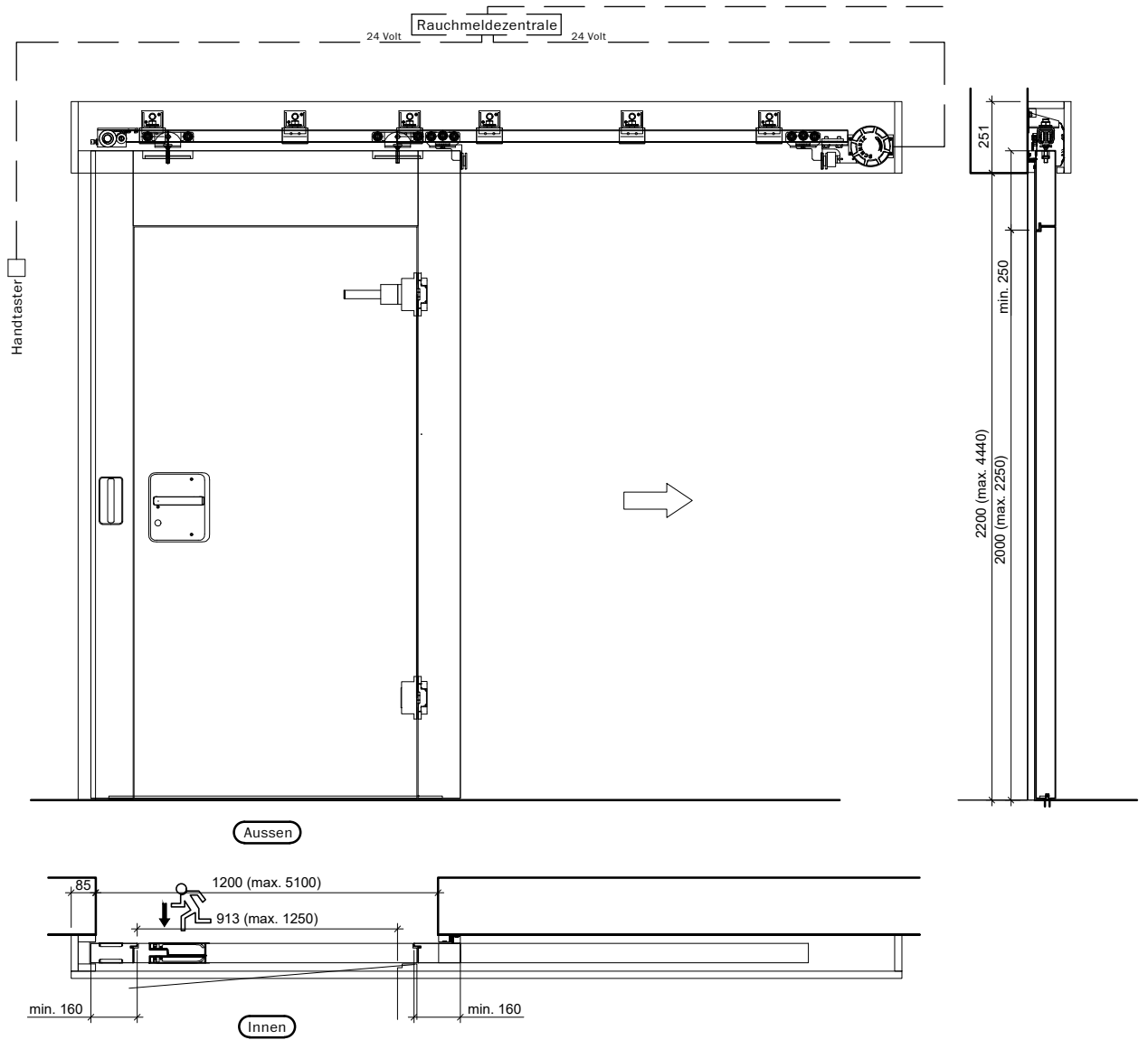

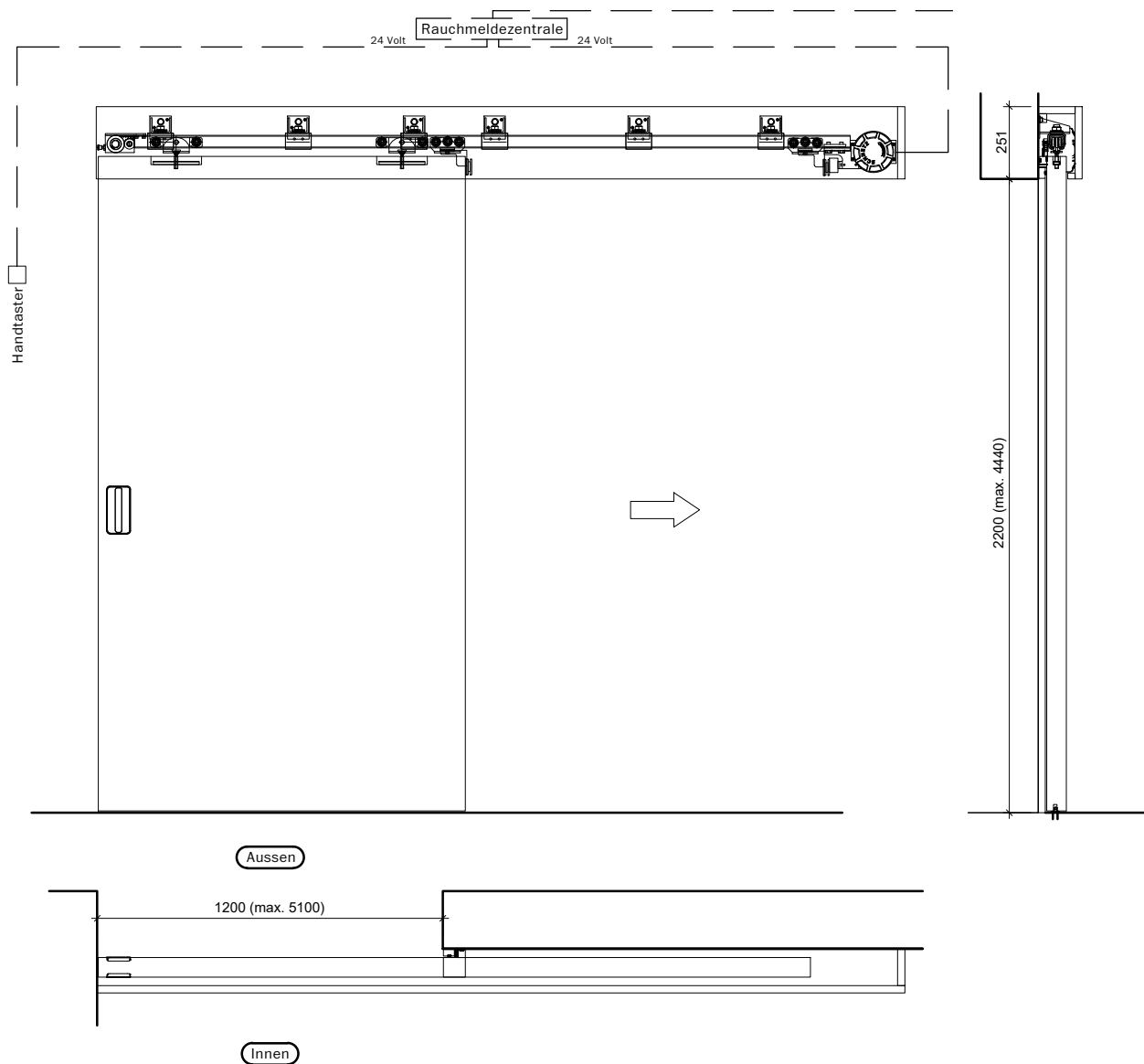

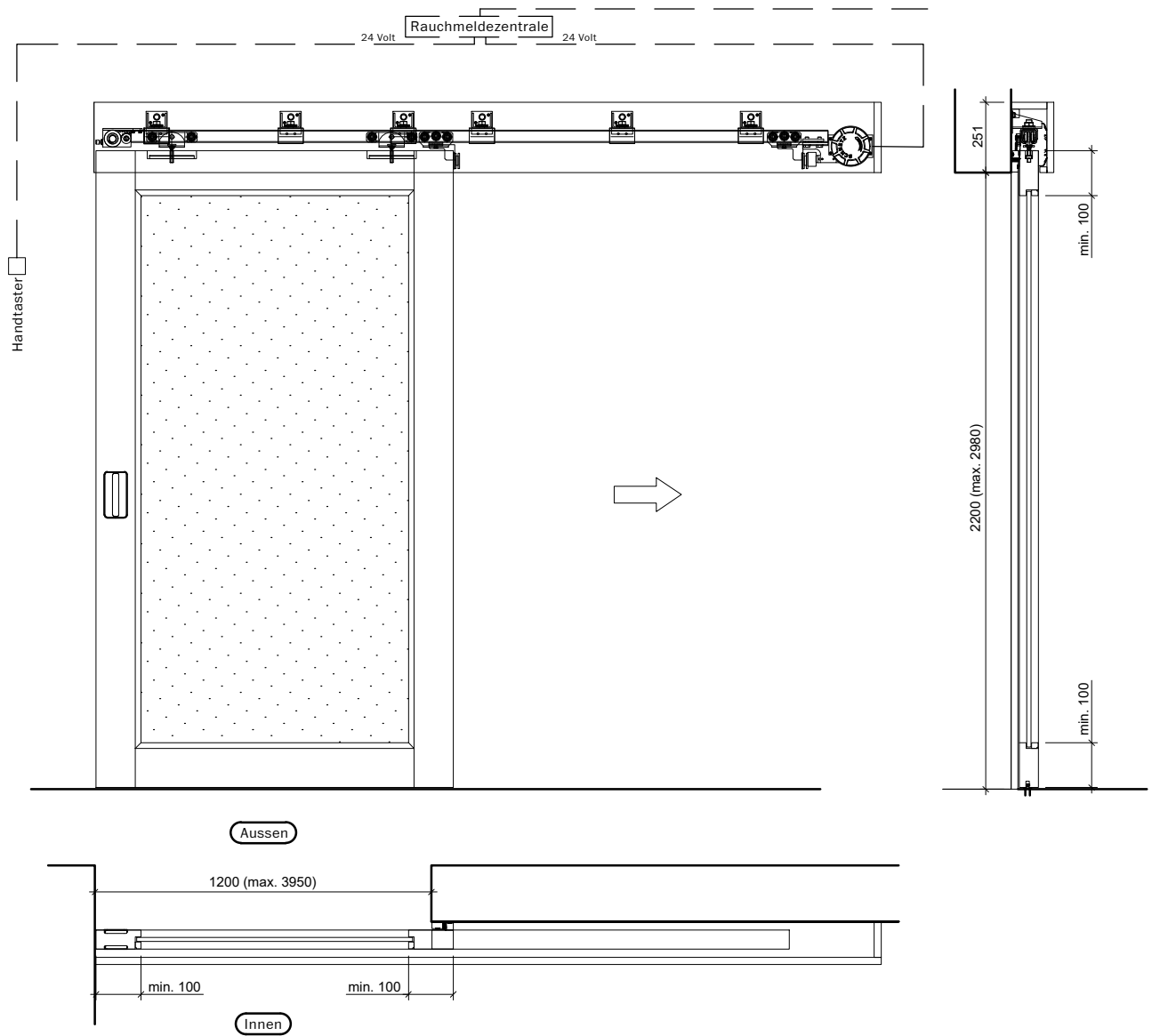

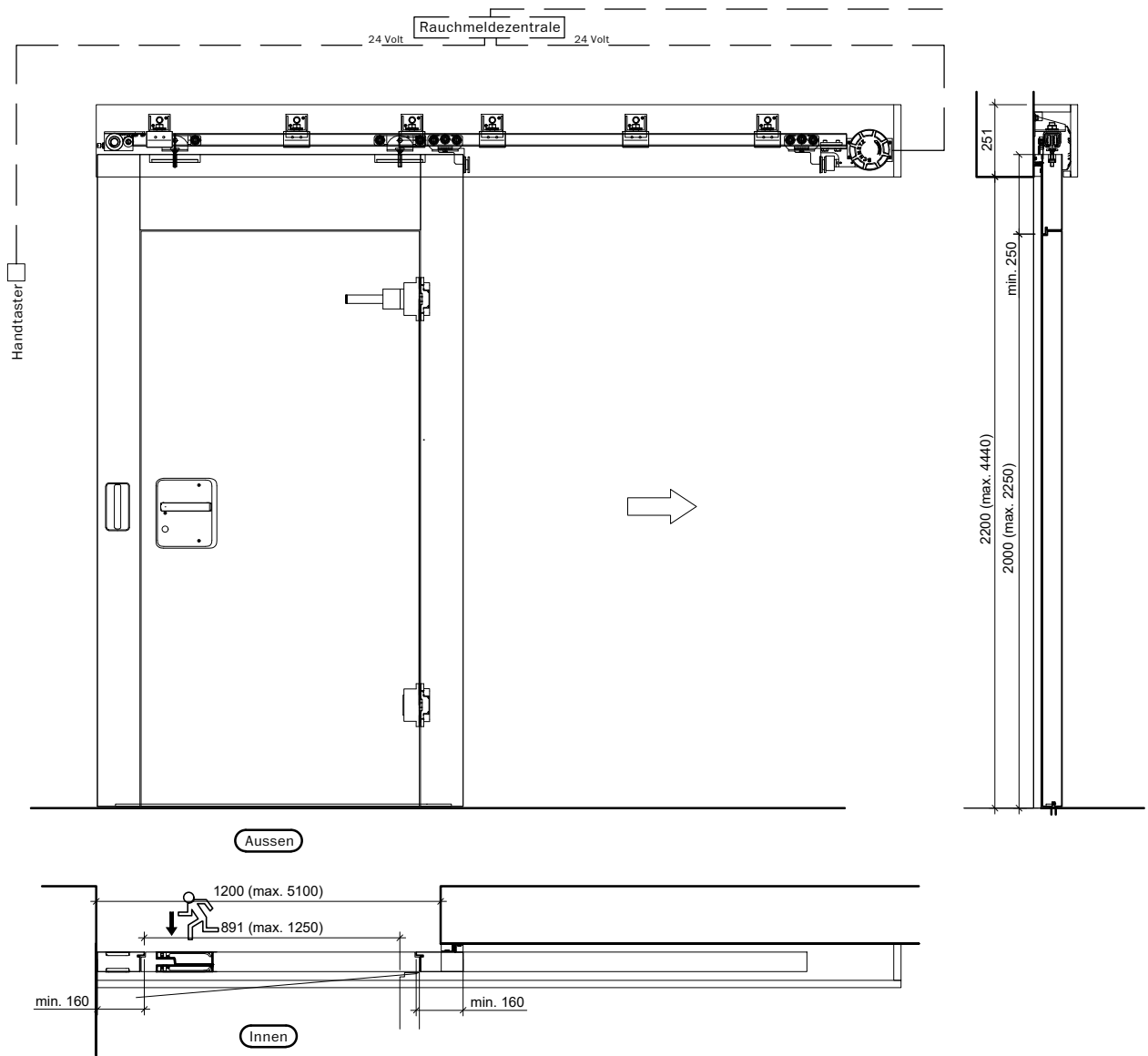

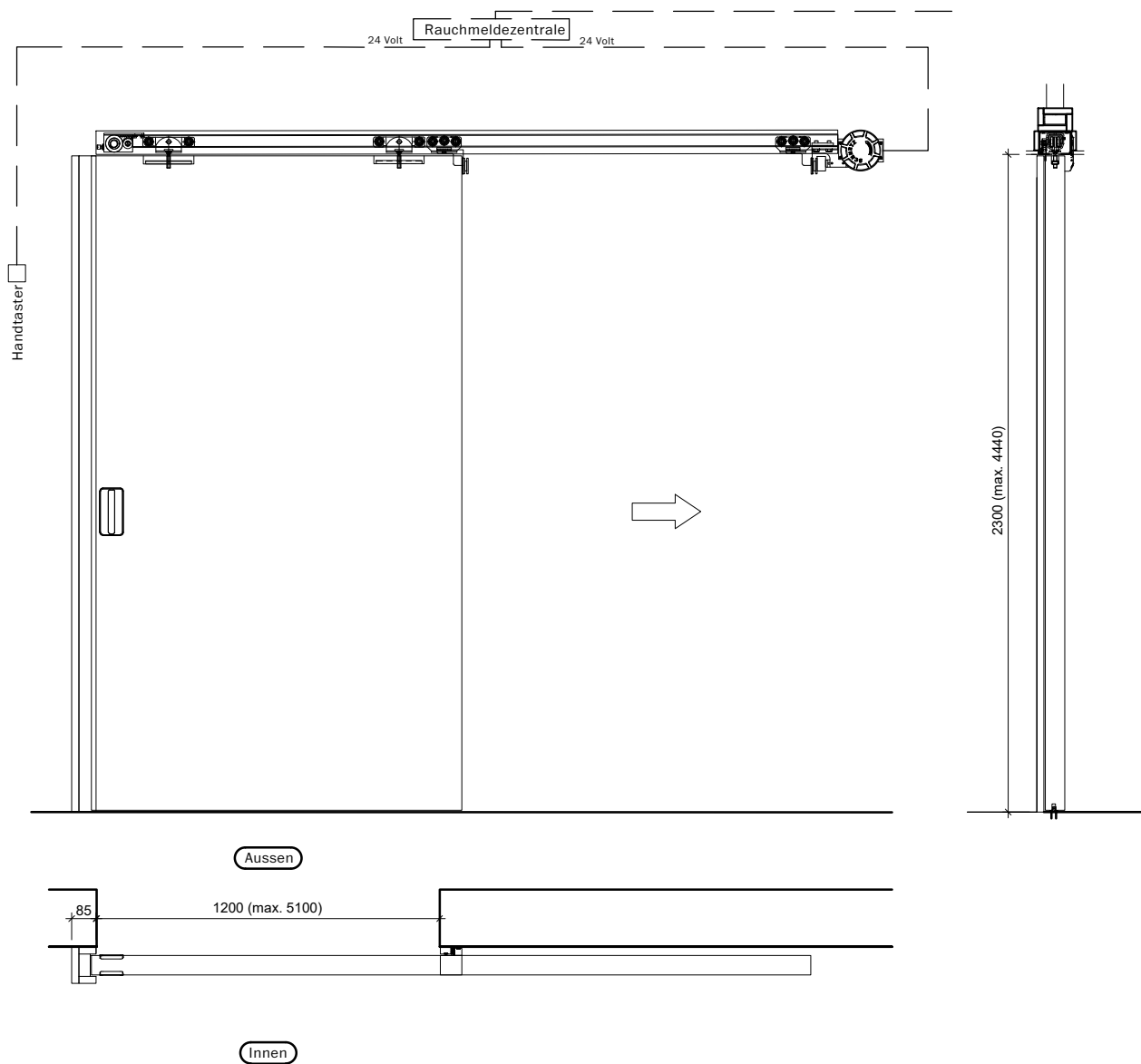

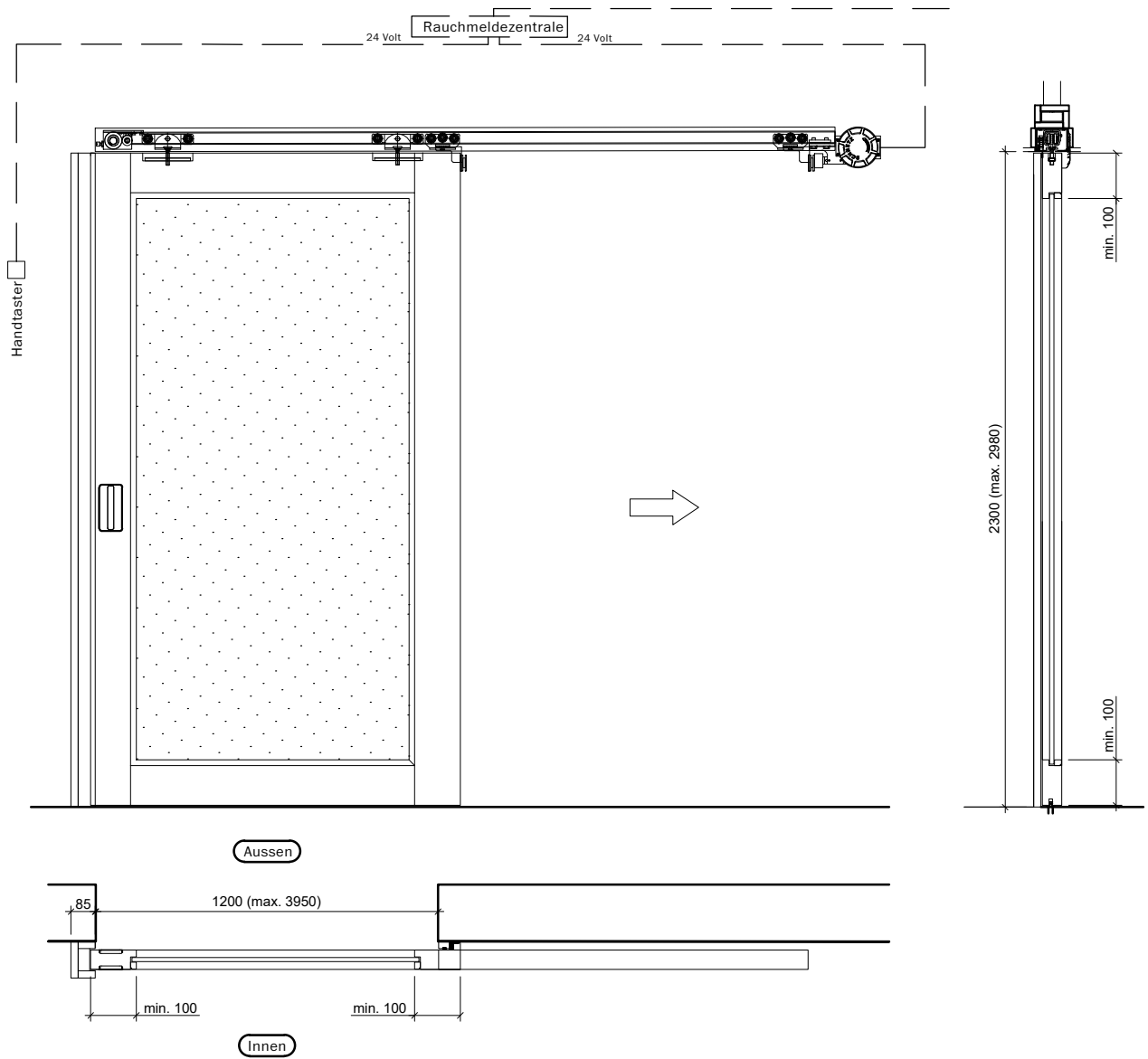

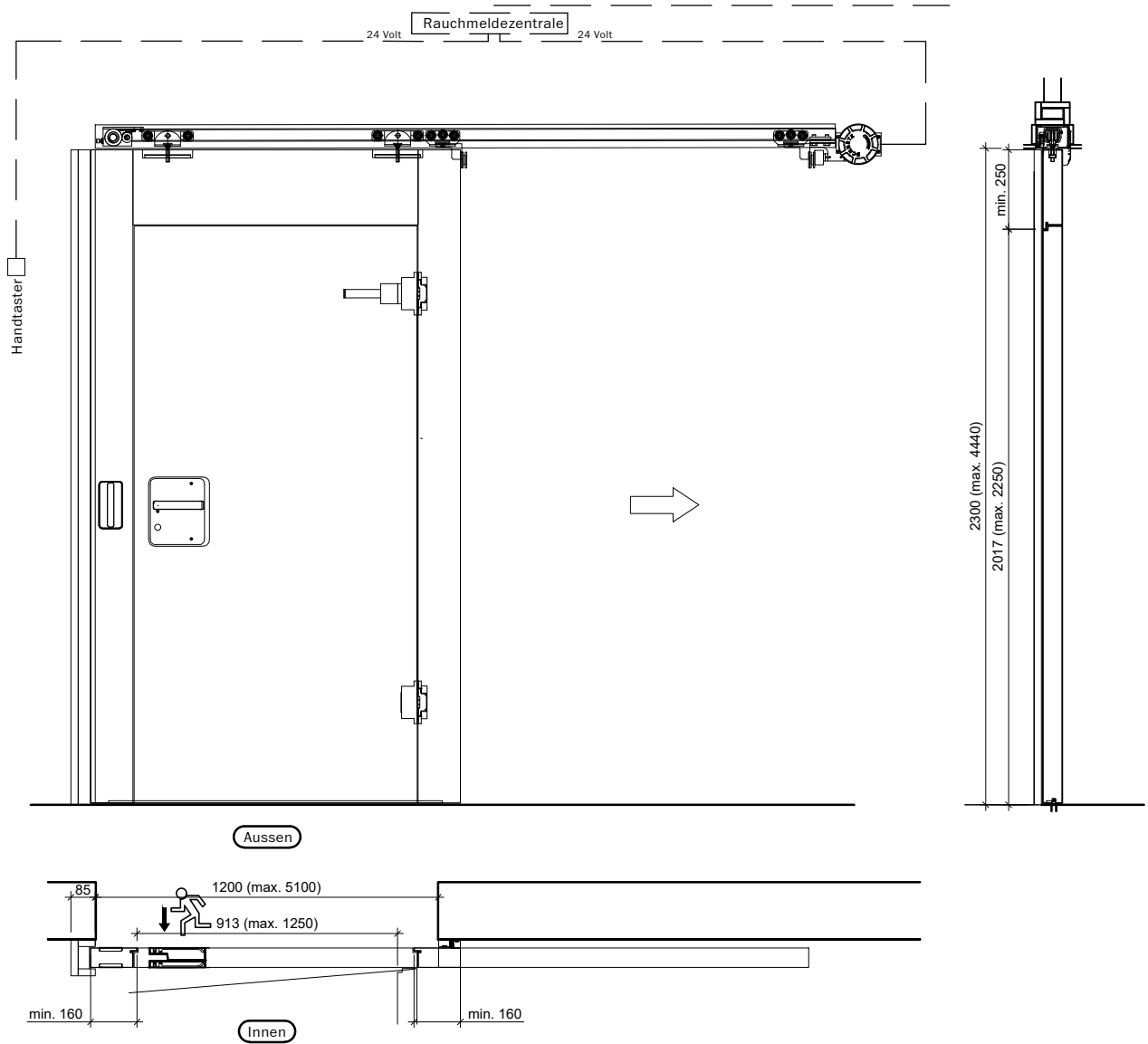

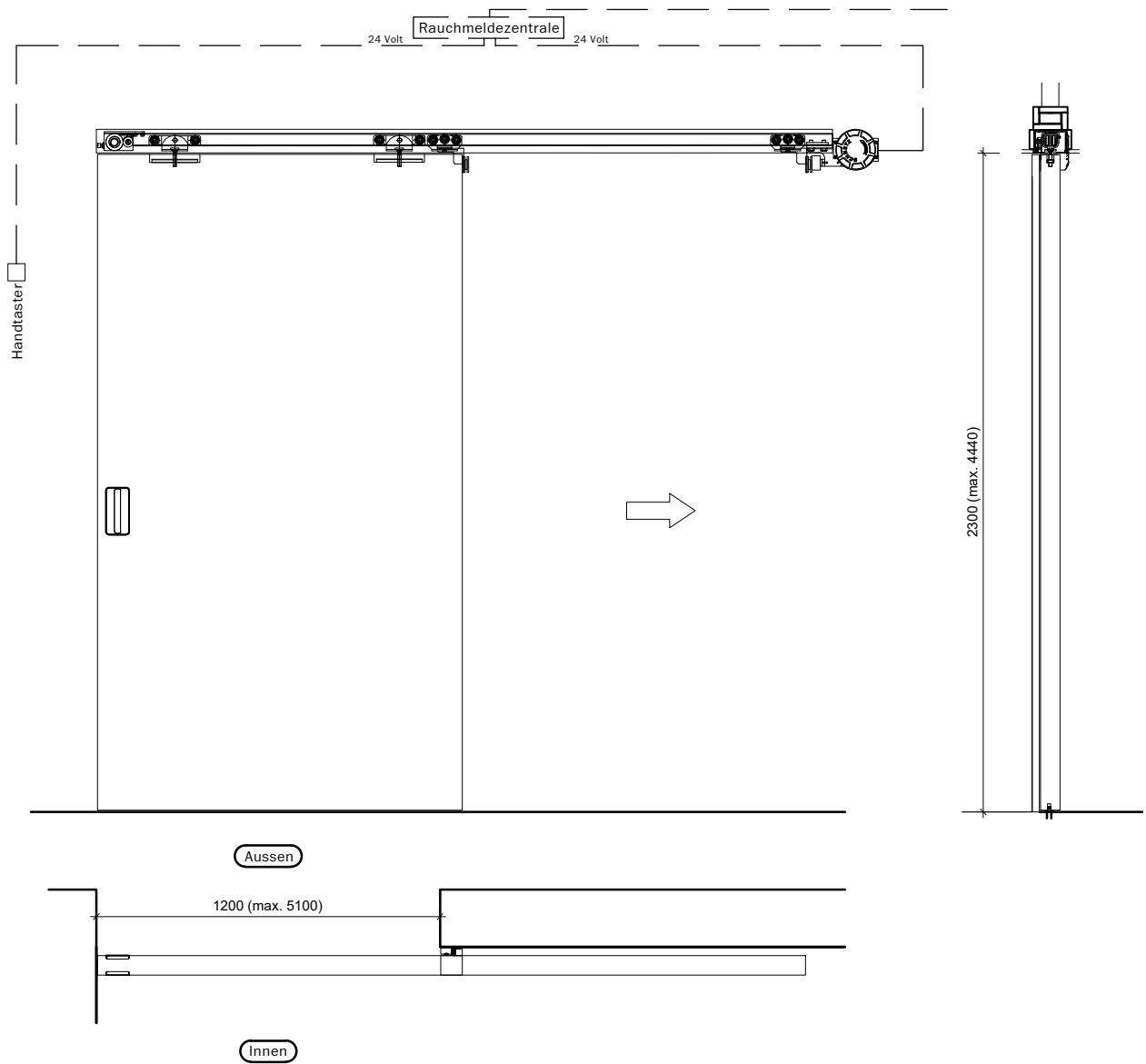

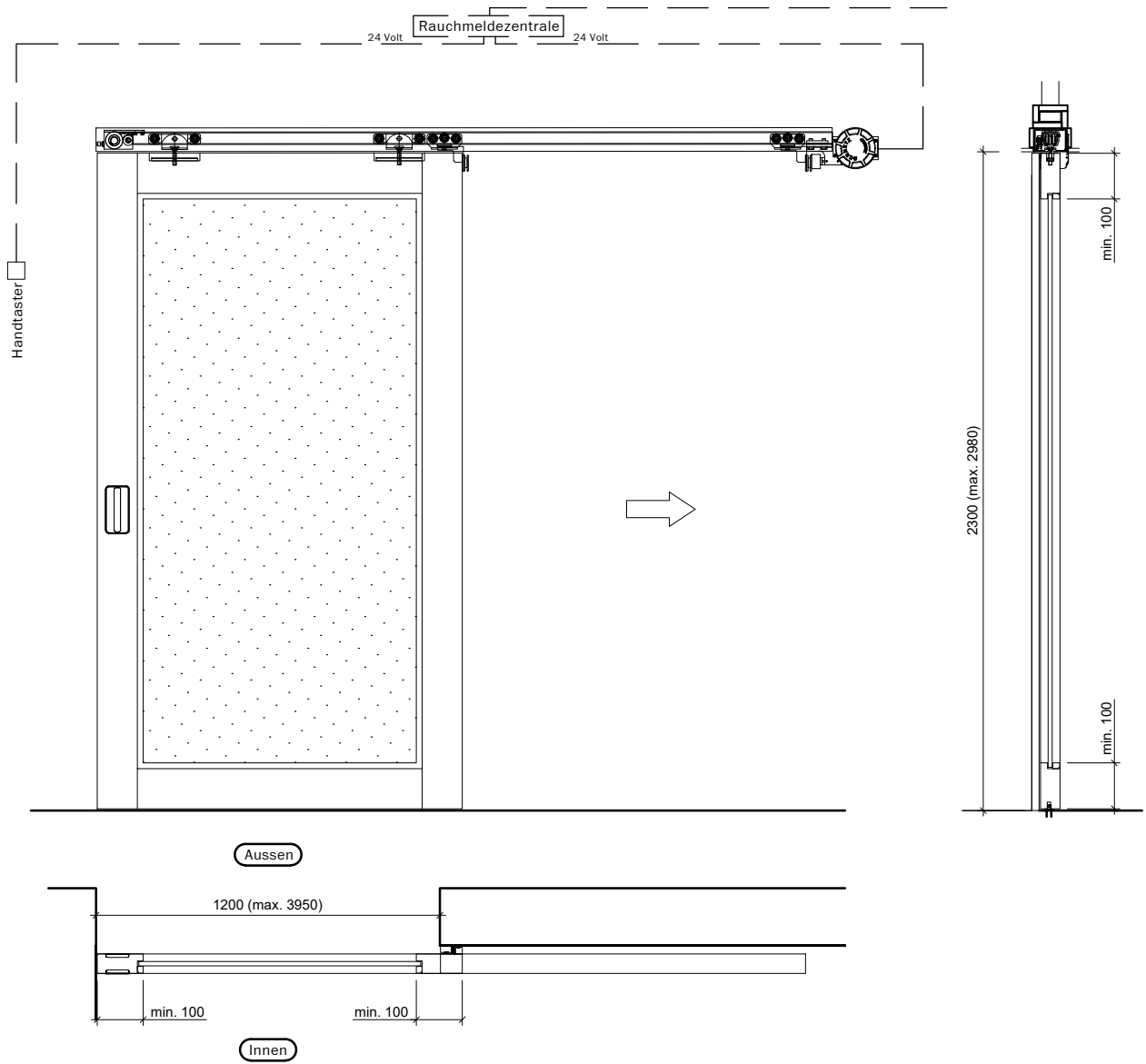

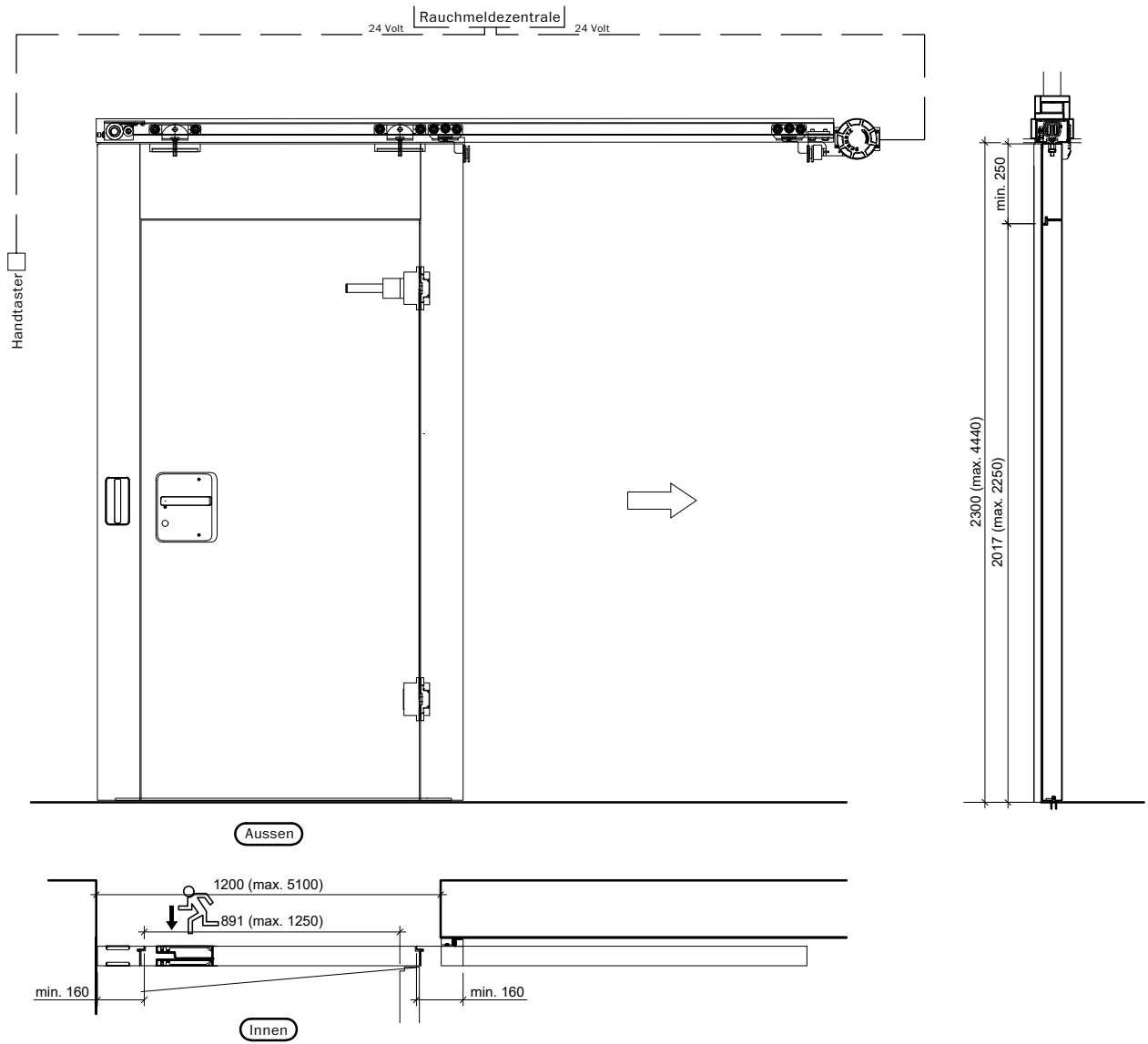

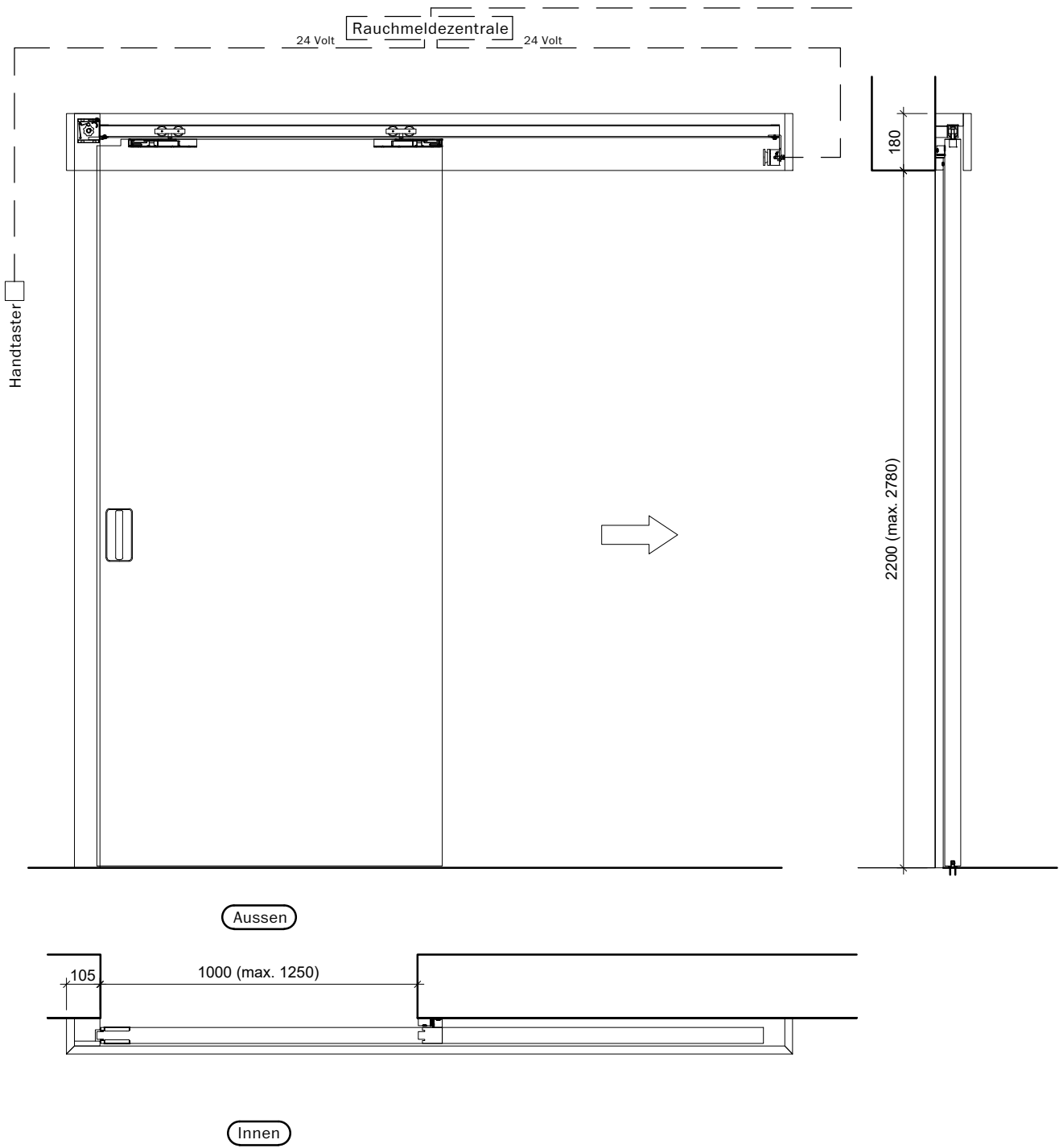

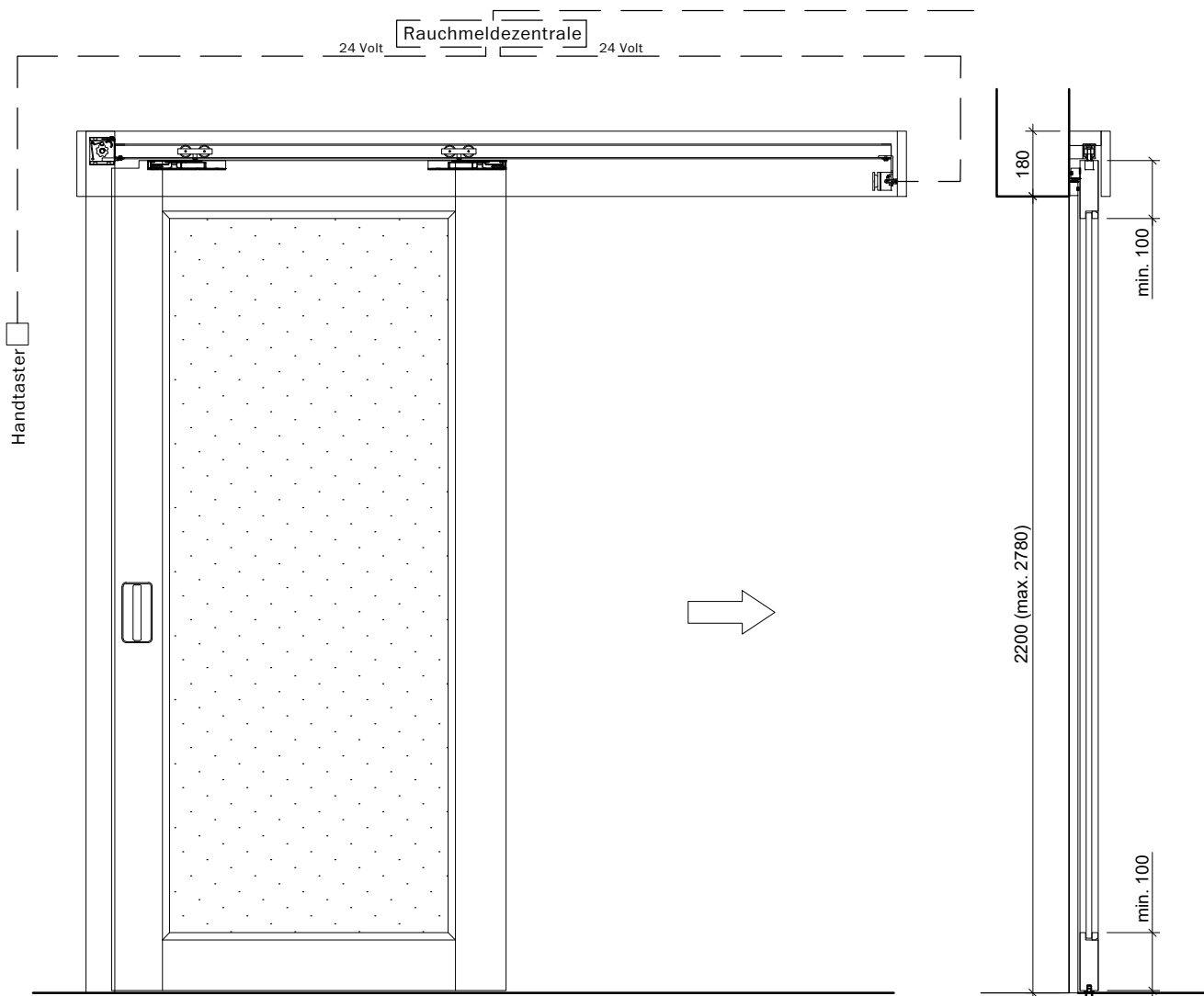

Aussen

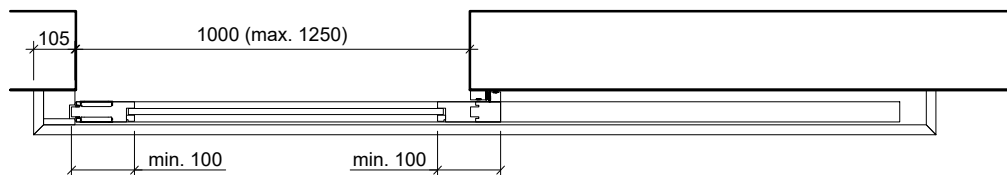

Innen



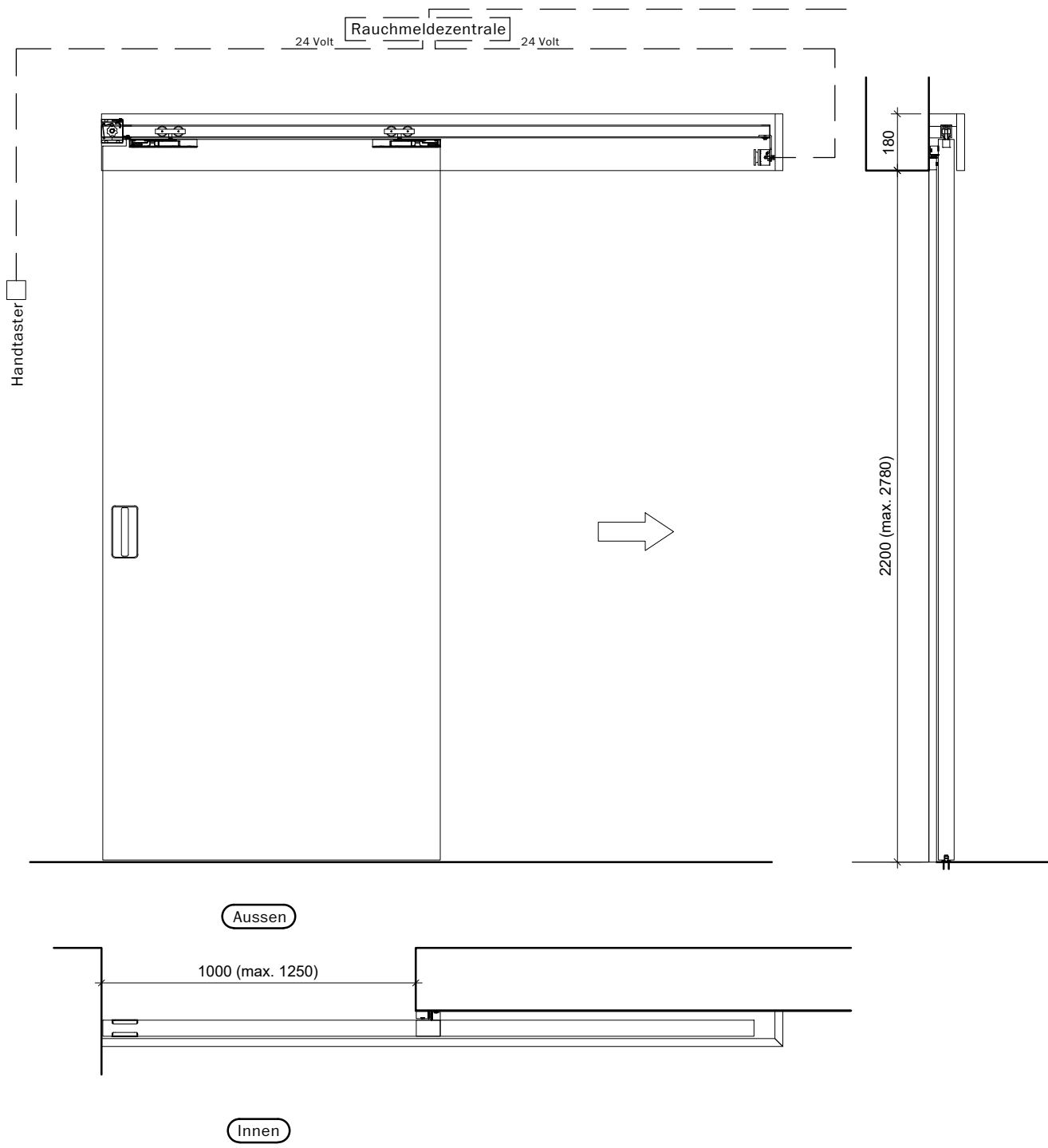

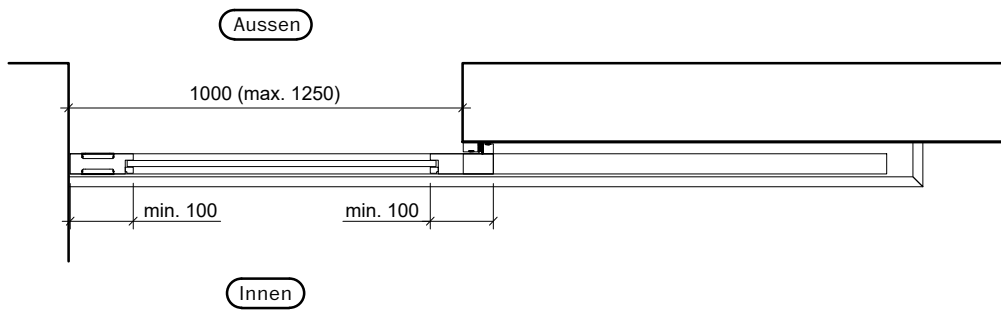
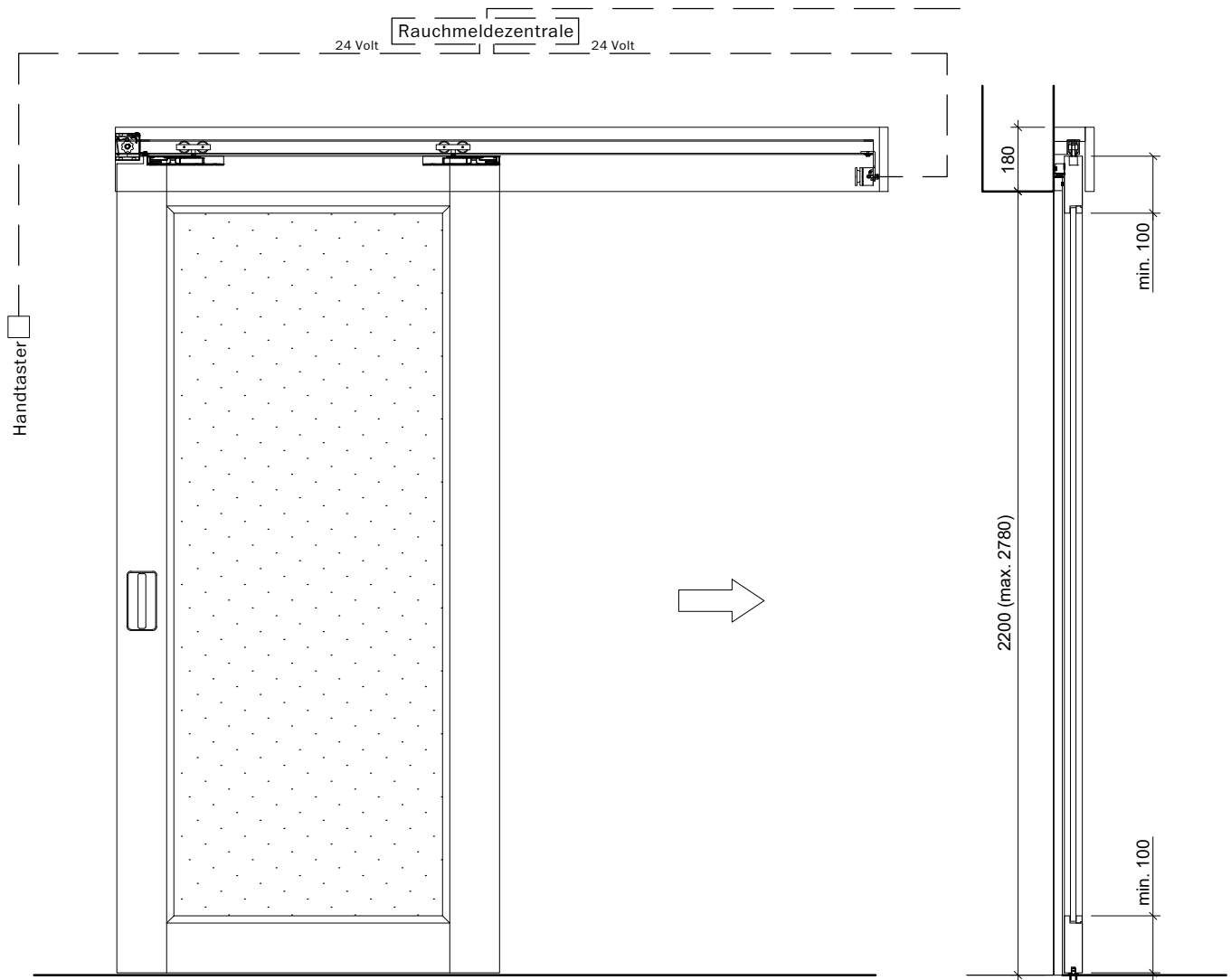

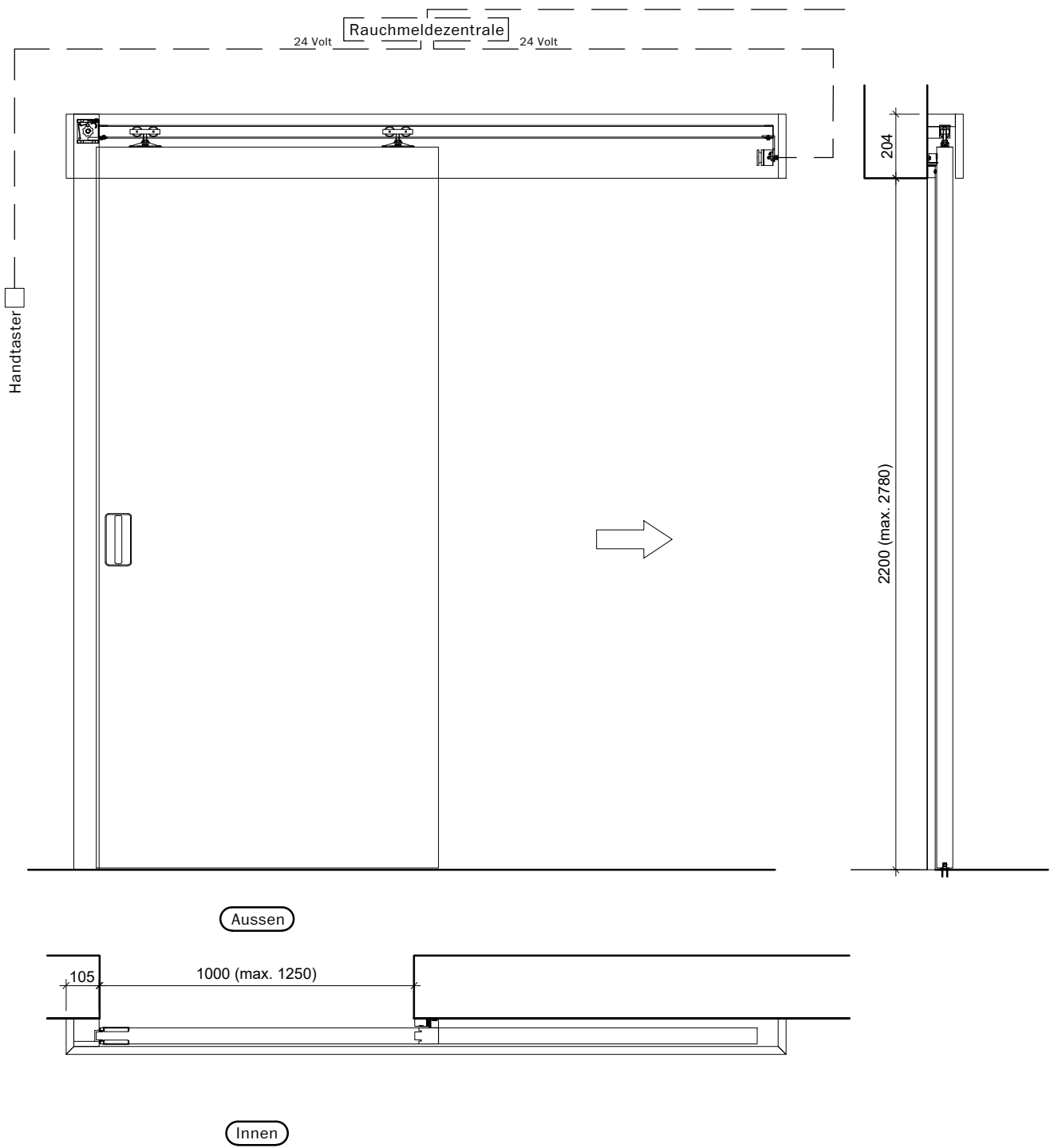

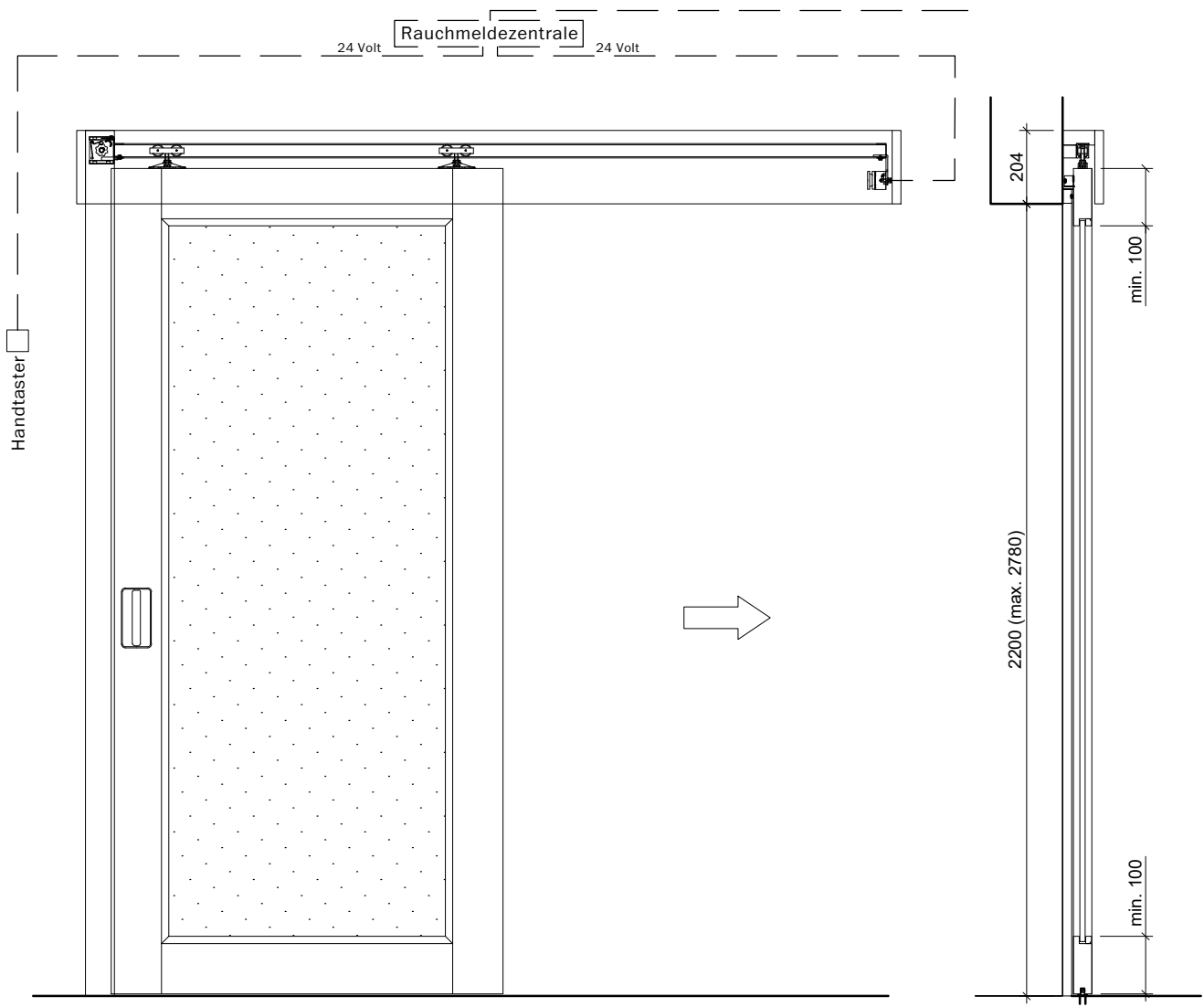

Aussen

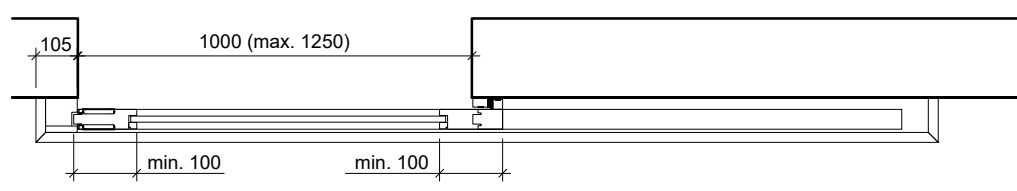

Innen

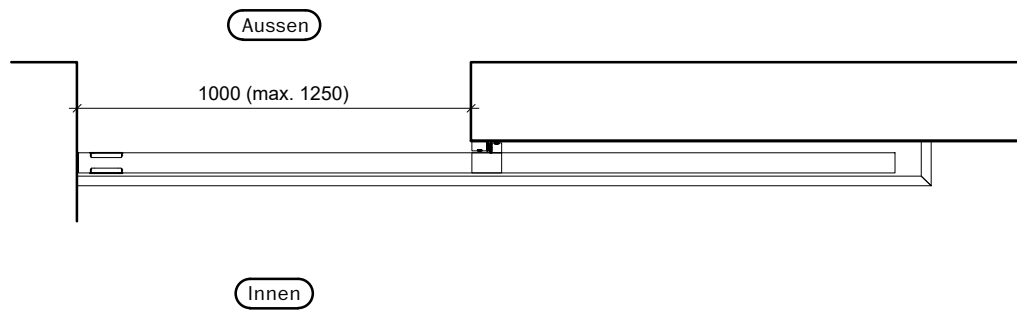
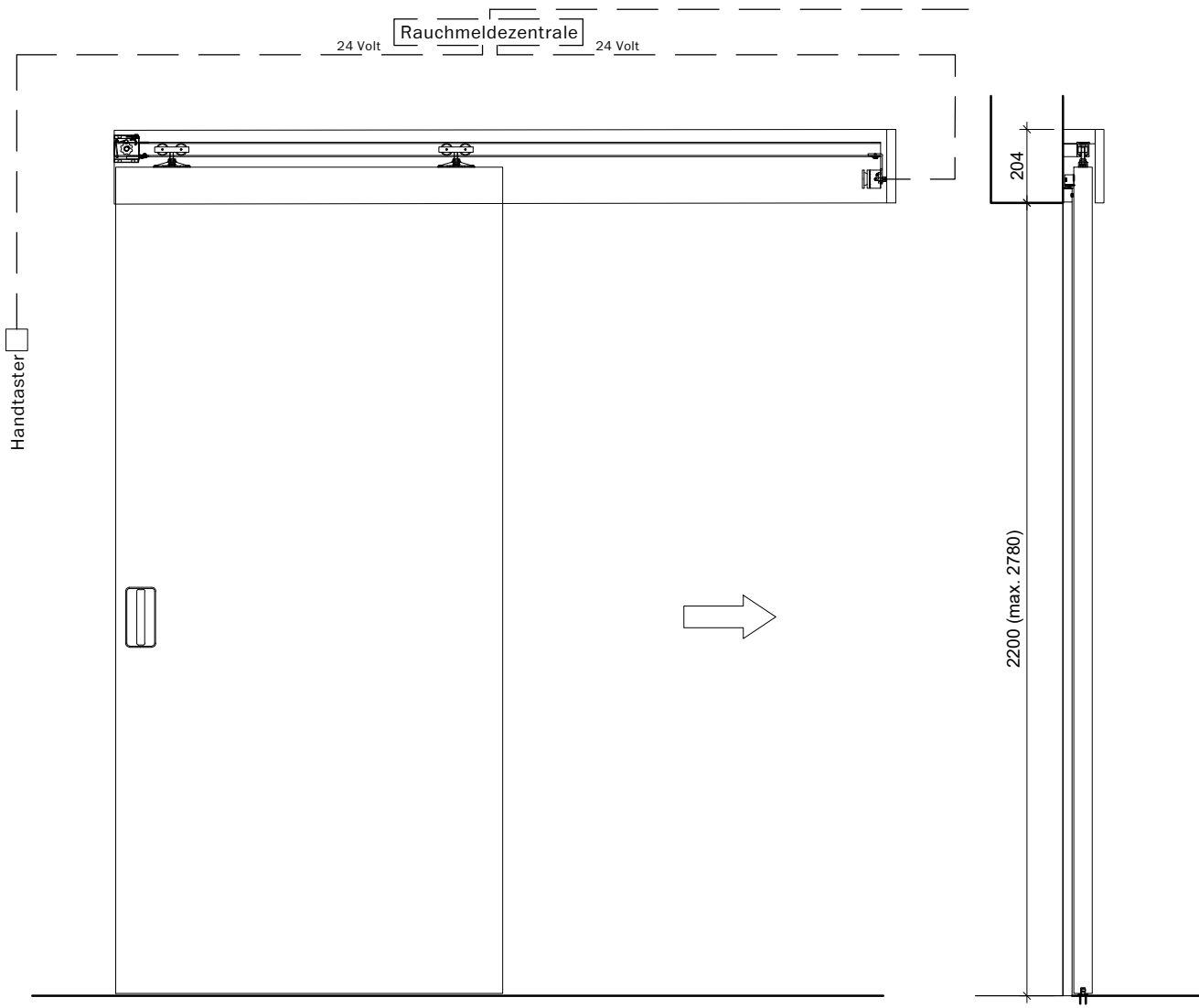

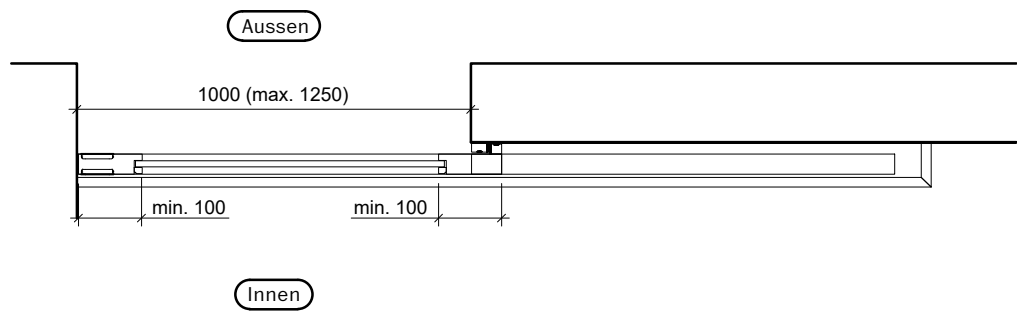
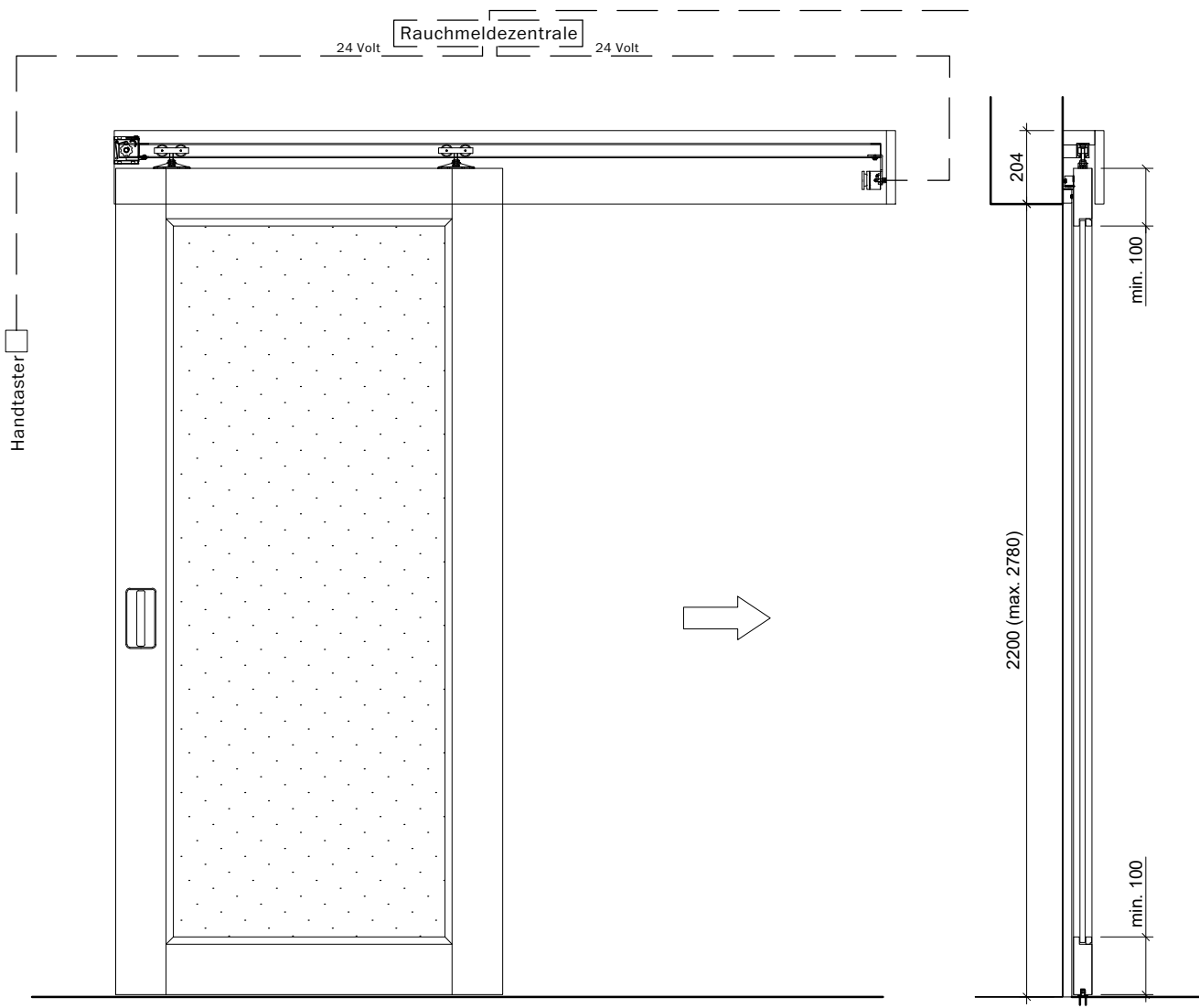

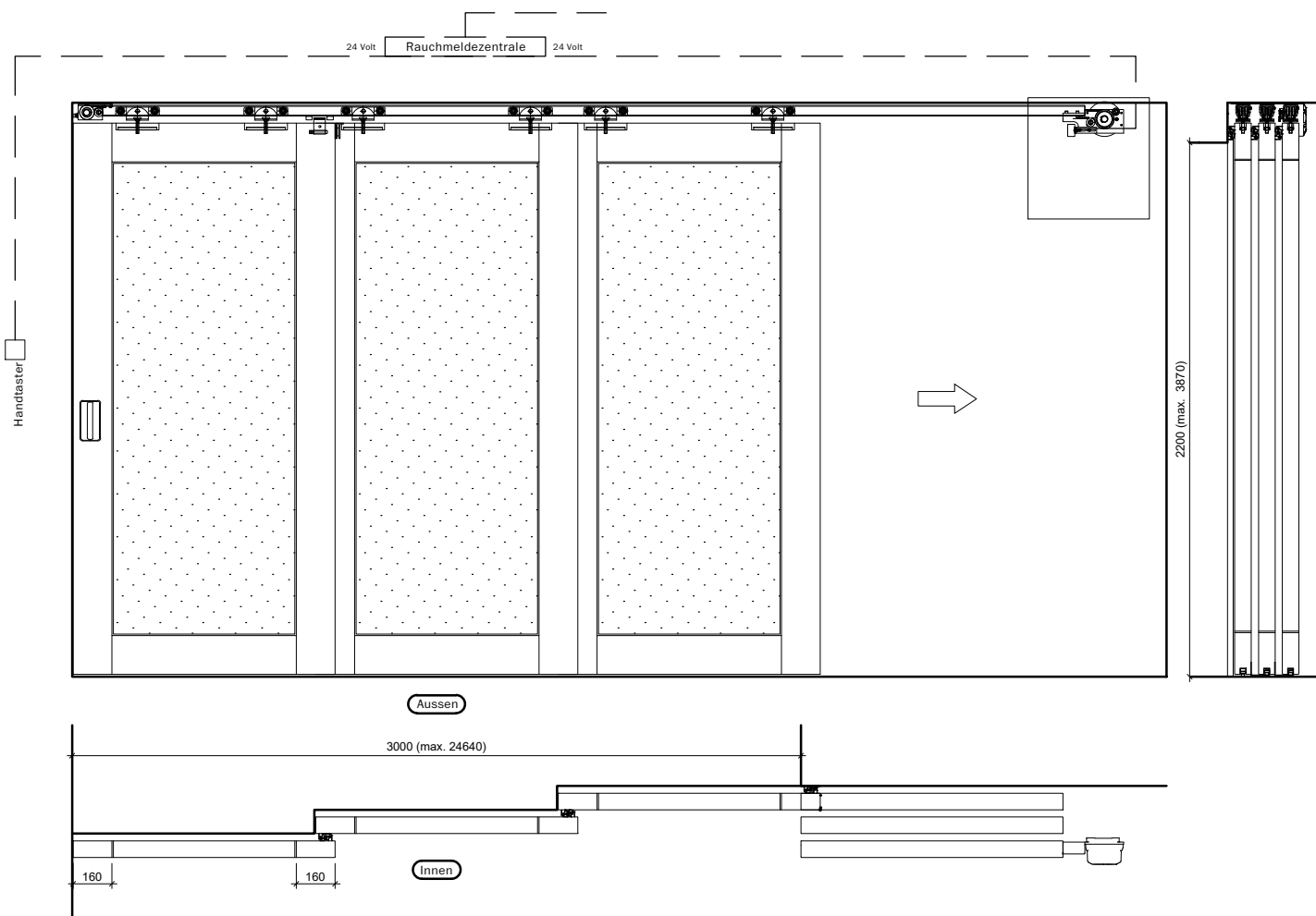

Teleskop-Schiebetor 2-teilig: Bmax= 6160 mm,	Hmax=3870 mm, Amax=15,94 m2
Teleskop-Schiebetor 3-teilig: Bmax= 9240 mm,	Hmax=3870 mm, Amax=23,91 m2
Teleskop-Schiebetor 4-teilig: Bmax=12370 mm,	Hmax=3870 mm, Amax=31,88 m2
Teleskop-Schiebetor 5-teilig: Bmax=15400 mm,	Hmax=3870 mm, Amax=39,85 m2
Teleskop-Schiebetor 6-teilig: Bmax=18480 mm,	Hmax=3870 mm, Amax=47,82 m2
Teleskop-Schiebetor 7-teilig: Bmax=21560 mm,	Hmax=3870 mm, Amax=55,79 m2
Teleskop-Schiebetor 8-teilig: Bmax=24640 mm,	Hmax=3870 mm, Amax=63,76 m2

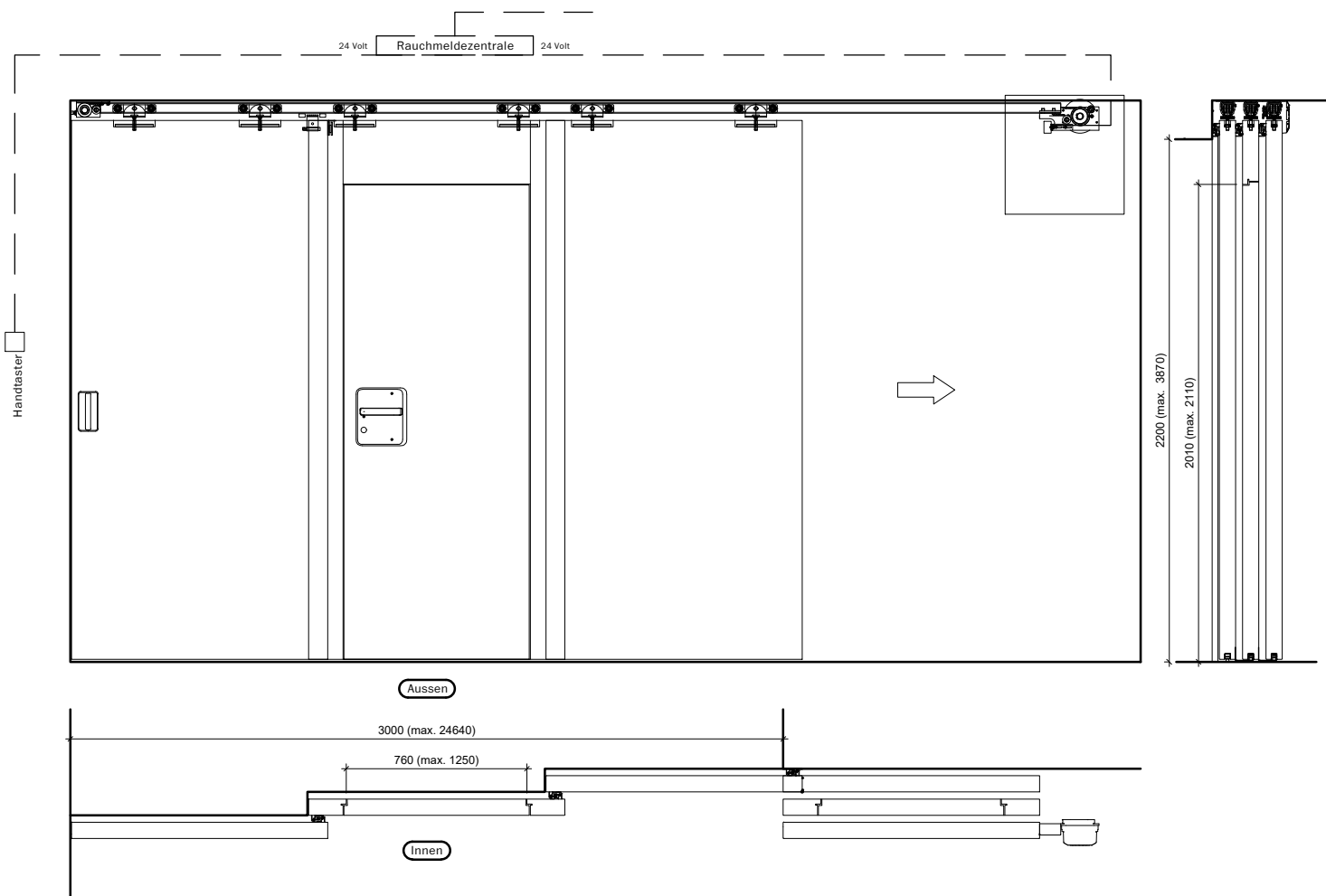

Teleskop-Schiebetor 2-teilig: Bmax= 6160 mm,	Hmax=3870 mm, Amax=15,94 m2
Teleskop-Schiebetor 3-teilig: Bmax= 9240 mm,	Hmax=3870 mm, Amax=23,91 m2
Teleskop-Schiebetor 4-teilig: Bmax=12370 mm,	Hmax=3870 mm, Amax=31,88 m2
Teleskop-Schiebetor 5-teilig: Bmax=15400 mm,	Hmax=3870 mm, Amax=39,85 m2
Teleskop-Schiebetor 6-teilig: Bmax=18480 mm,	Hmax=3870 mm, Amax=47,82 m2
Teleskop-Schiebetor 7-teilig: Bmax=21560 mm,	Hmax=3870 mm, Amax=55,79 m2
Teleskop-Schiebetor 8-teilig: Bmax=24640 mm,	Hmax=3870 mm, Amax=63,76 m2

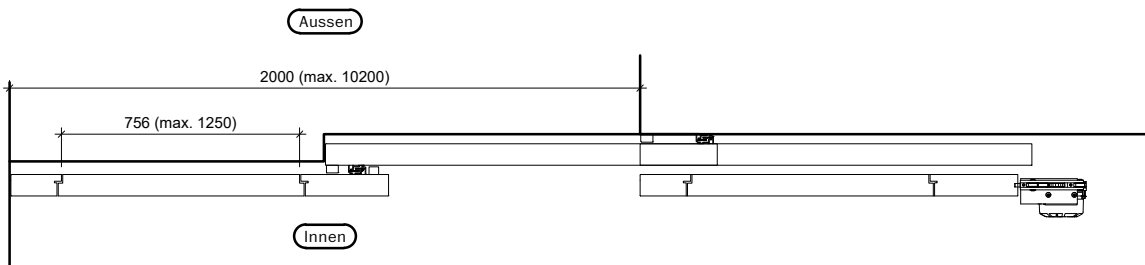
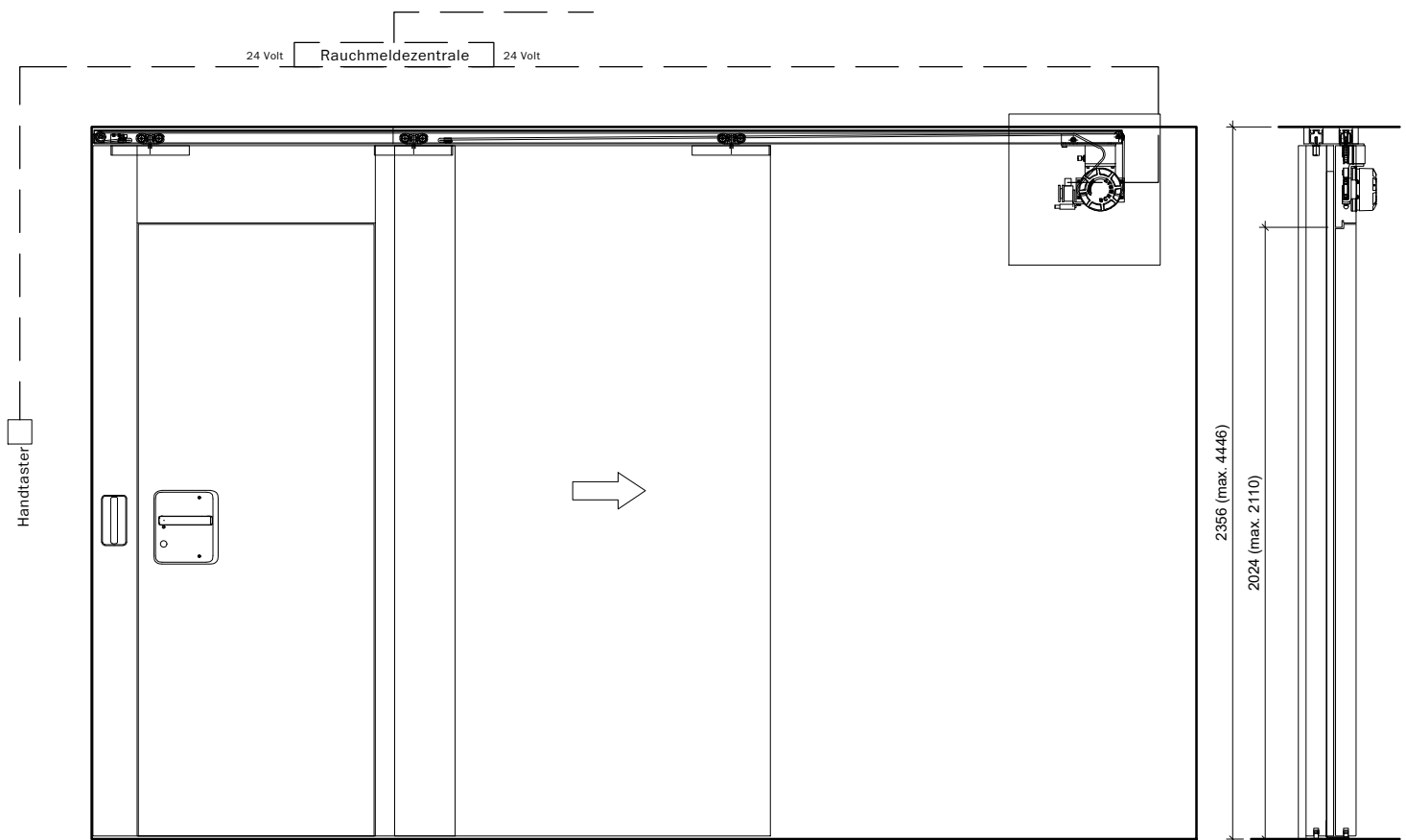

Teleskop-Schiebetor 2-3 teilig: Bmax= 10200 mm, Hmax=4446 mm, Amax=45,35 m²

